

For a Free Quote:

Web: EnergyPal.com/solar

Call: 1-800-990-3725

Email: contact@energypal.com

EnergyPal

Solar Panel Guide Specification Data Sheet

Jiangsu Aoxuan Photoelectric Technology Co., Ltd.

AOX-60MPRO350-370W

AOX-60MPRO-365W

Also available on the web at

EnergyPal.com/jiangsu-aoxuan-photoelectric-technology-co-ltd-solar-panels/aox-60mpro-365w

AOX-60M/PRO

350-370W Mono Module

High Efficiency
Higher Output Power
Low LID Mono PERC
Lower Temperature Coefficient
With Full Technology

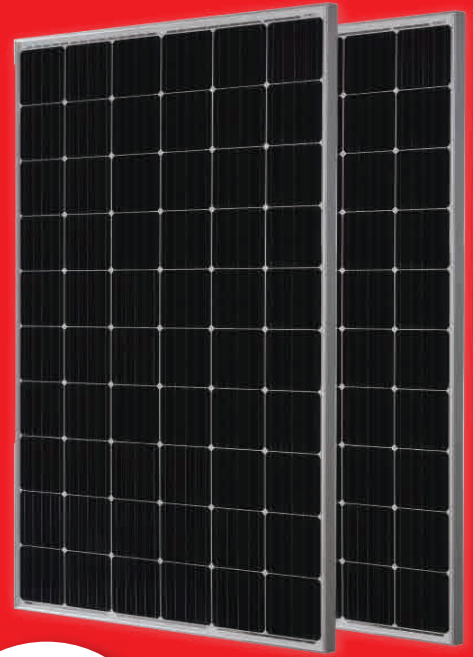

10-year Warranty for Materials and Processing;
25-year Warranty for Extra Linear Power Output

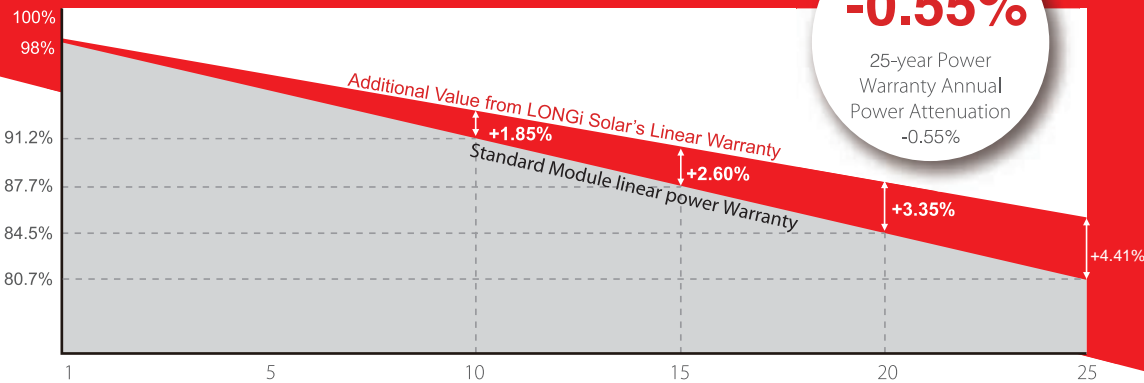

-0.55%

25-year Power
Warranty Annual
Power Attenuation
-0.55%

Complete System and Product Certifications

IEC 61215, IEC 61730
ISO 9001:2008
ISO 14001:2004
OHSAS 18001:2007



Positive power tolerance (0 ~ +5W) guaranteed

High module conversion efficiency (up to 19.8%)

Slower power degradation enabled by Low LID Mono PERC technology: first year <2%, 0.55% year 2-25

Solid PID resistance ensured by solar cell process optimization and careful module BOM selection

Reduced resistive loss with lower operating current

Higher energy yield with lower operating temperature

Reduced hot spot risk with optimized electrical design and lower operating current

AOX-60M/PRO 350-370W MBB

Design (mm)

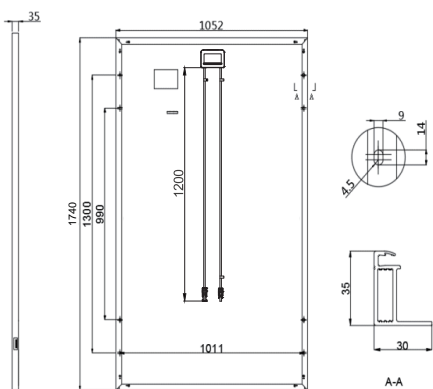

Units: mm(inch)
Tolerance:
Length: ±2mm
Width: ±2mm
Height: ±1mm
Pitch-row: ±1mm

Mechanical Parameters

Cell Orientation: 60 (6*10)
Junction Box: IP68, three diodes
Output Cable: 4mm²
length can be customized
Glass: Single glass
3.2mm coated tempered glass
Frame: Anodized aluminum alloy frame
Weight: 19.5KG
Dimension: 1740*1052*35mm
Packaging: 30pcs per pallet
336pcs per 20'GP
858pcs per 40'HQ

Operating Parameters

Operational Temperature: -40°C ~ +85°C
Power Output Tolerance: 0 ~ +5W
Voc and Isc Tolerance: ±3%
Maximum System Voltage: DC1500V (IEC/UL)
Maximum Series Fuse Rating: 20A
Nominal Operating Cell Temperature: 45±2°C
Safety Class: Class II
Fire Rating: UL type 1 or type 2

Electrical Characteristics

Test uncertainty for Pmax: ±3%

Model Number	AOX-60M/PRO-350W		AOX-60M/PRO-355W		AOX-60M/PRO-360W		AOX-60M/PRO-365W		AOX-60M/PRO-370W	
	STC	NOCT	STC	NOCT	STC	NOCT	STC	NOCT	STC	NOCT
Maximum Power (Pmax/W)	350	259.3	355	263.0	360	266.7	365	270.4	370	274.1
Open Circuit Voltage (Voc/V)	40.5	37.8	40.7	38.0	40.9	38.2	41.1	38.4	41.3	38.5
Short Circuit Current (Isc/A)	11.02	8.89	11.10	8.95	11.20	9.03	11.28	9.09	11.37	9.17
Voltage at Maximum Power (Vmp/V)	33.3	30.8	33.5	30.9	33.7	31.1	33.9	31.3	34.1	31.5
Current at Maximum Power (Imp/A)	10.52	8.44	10.60	8.50	10.69	8.57	10.77	8.64	10.86	8.71
Module Efficiency(%)	19.1		19.4		19.7		19.9		20.2	

STC (Standard Testing Conditions): Irradiance 1000W/m², Cell Temperature 25°C, Spectra at AM1.5

NOCT (Nominal Operating Cell Temperature): Irradiance 800W/m², Ambient Temperature 20°C, Spectra at AM1.5, Wind at 1m/s

Temperature Ratings (STC)

Temperature Coefficient of Isc	+0.057%/°C
Temperature Coefficient of Voc	-0.286%/°C
Temperature Coefficient of Pmax	-0.370%/°C

Mechanical Loading

Front Side Maximum Static Loading	5400Pa
Rear Side Maximum Static Loading	2400Pa
Hailstone Test	25mm Hailstone at the speed of 23m/s

I-V Curve

Current-Voltage Curve(AOX-60M/PRO-360W)

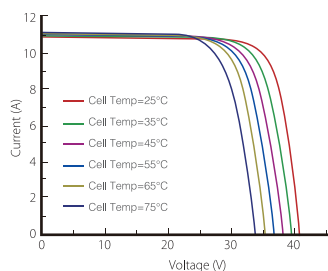

Power-Voltage Curve(AOX-60M/PRO-360W)

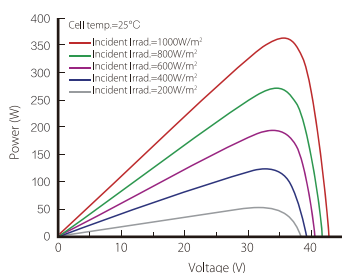

Current-Voltage Curve(AOX-60M/PRO-360W)

