

For a Free Quote:

Web: **EnergyPal.com/solar**

Call: **1-800-990-3725**

Email: **contact@energypal.com**

EnergyPal

Solar Panel Guide Specification Data Sheet

Qingdao Yinghua Solar Co., Ltd.

AS-6M 340-385W

AS-6M-375W

Also available on the web at
EnergyPal.com/qingdao-yinghua-solar-co-ltd-solar-panels/as-6m-375w

AS-6M

MONOCRYSTALLINE MODULE

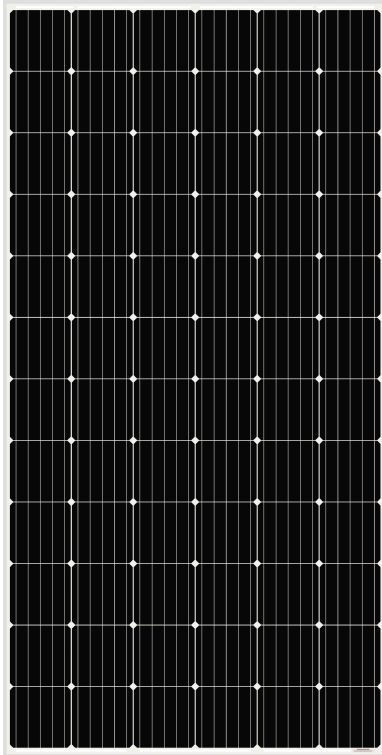

Passionately
committed to
delivering innovative
energy solution

ADVANCED PERFORMANCE & PROVEN ADVANTAGES

- High module conversion efficiency up to 19.84% through innovative five busbar cell technology.
- Low degradation and excellent performance under high temperature and low light conditions.
- Robust aluminum frame ensures the modules to withstand wind loads up to 3600Pa and snow loads up to 5400Pa.
- High reliability against extreme environmental conditions (passing salt mist, ammonia and hail tests).
- Potential induced degradation (PID) resistance.
- Positive power tolerance of 0 ~ +3 %.

CERTIFICATIONS

- IEC 61215, IEC 61730, UL 1703, IEC 62716, IEC 61701, IEC TS 62804, CE, CQC, ETL(USA), JET(Japan), J-PEC(Japan), KS(South Korea), BIS(India), MCS(UK), CEC(Australia), FSEC(FL-USA), CSI Eligible(CA-USA), Israel Electric(Israel), InMetro(Brazil), TSE(Turkey)
- ISO9001:2015: Quality management system
- ISO14001:2015: Environmental management system
- OHSAS18001:2007: Occupational health and safety management system

SPECIAL WARRANTY

- 12 years limited product warranty.
- Limited linear power warranty: 12 years 91.2% of the nominal power output, 30 years 80.6% of the nominal power output.

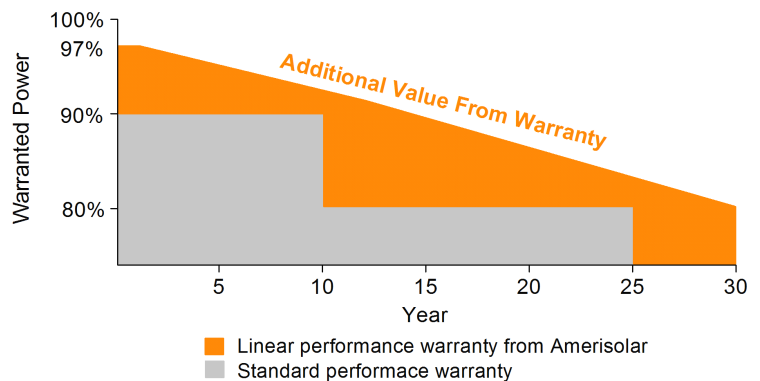

ELECTRICAL CHARACTERISTICS AT STC

Maximum Power (P_{max})	340W	345W	350W	355W	360W	365W	370W	375W	380W	385W
Open Circuit Voltage (V_{OC})	46.8V	47.0V	47.2V	47.4V	47.6V	47.8V	48.0V	48.2V	48.4V	48.6V
Short Circuit Current (I_{SC})	9.42A	9.50A	9.57A	9.64A	9.71A	9.78A	9.85A	9.92A	9.99A	10.06A
Voltage at Maximum Power (V_{mp})	38.2V	38.4V	38.6V	38.8V	39.0V	39.2V	39.4V	39.6V	39.8V	40.0V
Current at Maximum Power (I_{mp})	8.91A	8.99A	9.07A	9.15A	9.24A	9.32A	9.40A	9.47A	9.55A	9.63A
Module Efficiency (%)	17.52	17.78	18.04	18.30	18.55	18.81	19.07	19.33	19.58	19.84
Operating Temperature	-40°C to +85°C									
Maximum System Voltage	1000V DC/1500V DC									
Fire Resistance Rating	Type 1(in accordance with UL 1703)/Class C(IEC 61730)									
Maximum Series Fuse Rating	15A									

STC: Irradiance 1000W/m², Cell temperature 25°C, AM1.5

ELECTRICAL CHARACTERISTICS AT NOCT

Maximum Power (P_{max})	253W	257W	261W	264W	268W	272W	276W	279W	283W	287W
Open Circuit Voltage (V_{OC})	43.3V	43.5V	43.7V	43.9V	44.1V	44.3V	44.5V	44.7V	44.9V	45.1V
Short Circuit Current (I_{SC})	7.63A	7.70A	7.75A	7.81A	7.87A	7.92A	7.98A	8.04A	8.09A	8.15A
Voltage at Maximum Power (V_{mp})	35.1V	35.3V	35.5V	35.7V	35.9V	36.1V	36.3V	36.5V	36.7V	36.9V
Current at Maximum Power (I_{mp})	7.21A	7.29A	7.36A	7.40A	7.47A	7.54A	7.61A	7.65A	7.72A	7.78A

NOCT: Irradiance 800W/m², Ambient temperature 20°C, Wind Speed 1 m/s

MECHANICAL CHARACTERISTICS

Cell type	Monocrystalline 6inch
Number of cells	72 (6x12)
Module dimensions	1956x992x40mm (77.01x39.06x1.57inches)
Weight	21kg (46.3lbs)
Front cover	3.2mm (0.13inches) tempered glass with AR coating
Frame	Anodized aluminum alloy
Junction box	IP67, 3 diodes
Cable	4mm ² (0.006inches ²), 1000mm (39.37inches)
Connector	MC4 or MC4 compatible

TEMPERATURE CHARACTERISTICS

Nominal Operating Cell Temperature (NOCT)	45°C±2°C
Temperature Coefficients of P_{max}	-0.38%/°C
Temperature Coefficients of V_{OC}	-0.29%/°C
Temperature Coefficients of I_{SC}	0.052%/°C

PACKAGING

Standard packaging	26pcs/pallet
Module quantity per 20' container	260pcs
Module quantity per 40' container	624pcs(GP)/684pcs(HQ)

ENGINEERING DRAWINGS

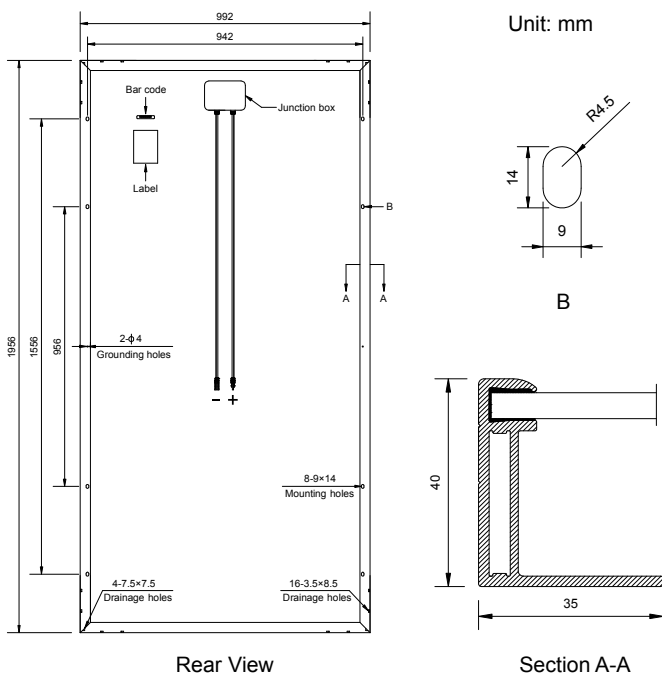

IV CURVES

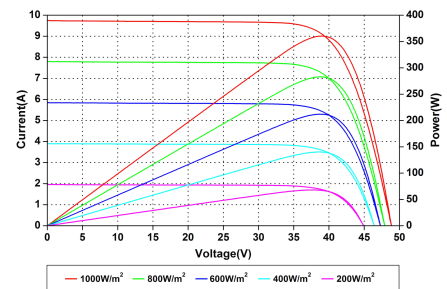

Current-Voltage and Power-Voltage Curves at Different Irradiances

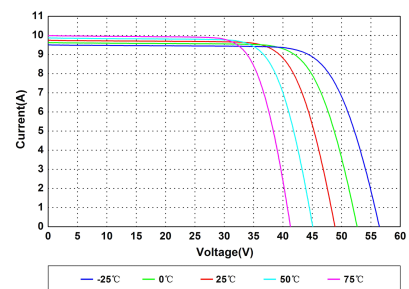

Current-Voltage Curves at Different Temperatures

Specifications in this datasheet are subject to change without prior notice.