

For a Free Quote:

Web: EnergyPal.com/solar

Call: 1-800-990-3725

Email: contact@energypal.com

EnergyPal

Solar Panel Guide Specification Data Sheet

**Eco Delta Power Co., Ltd.
ED190-200-210-6P
ED210-6P**

Also available on the web at
EnergyPal.com/eco-delta-power-co-ltd-solar-panels/ed210-6p



Poly-crystalline Solar Module

ED190-6P
ED200-6P
ED210-6P

Warranty

10-year repair and workmanship warranty
12-year warranty at 90% power output
25-year warranty at 80% power output

Typical Electrical Characteristics



Models	ED190-6P	ED200-6P	ED210-6P
Max. Power (Pmax)	190Wp	200Wp	210Wp
Optimum Operating Voltage (Vm)	35.6V	35.8V	36.2V
Optimum Operating Current (Im)	5.34A	5.59A	5.80A
Open-circuit Voltage (Voc)	42.7V	43.0V	43.44V
Short-circuit Current (Isc)	5.77A	6.04A	6.26A
Module efficiency	14.5%	15.3%	16.0%

Note: the specifications are obtained under the Standard Test Condition (STC): 1,000W/m², Am 1.5, Cell Temperature 25°C

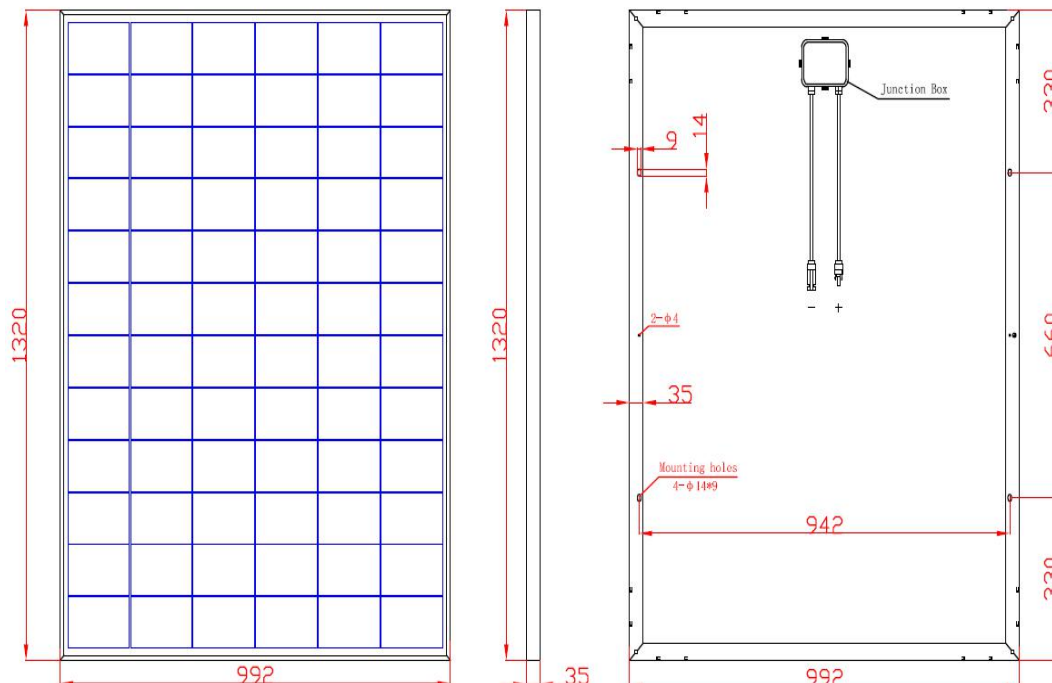

Solar cell	Poly
Power Tolerance (Pmax)	0 ~ +3%
Numbers of cells	72pcs of cells in series
Module Dimension	1320×992×35mm
Weight	15.0Kg
Max. System Voltage	1000V DC
Max. Series Fuse Rating	—
Temperature cycling range	-40°C ~ +85°C
NOTC	47°C
Temperature coefficients of Isc	(+0.06%/°C)
Temperature coefficients of Voc	(-0.35%/°C)
Temperature coefficients of Pmax	(-0.4%/°C)
Load Capacity	480pcs/ 20'GP
	960pcs/ 40'GP

Certification

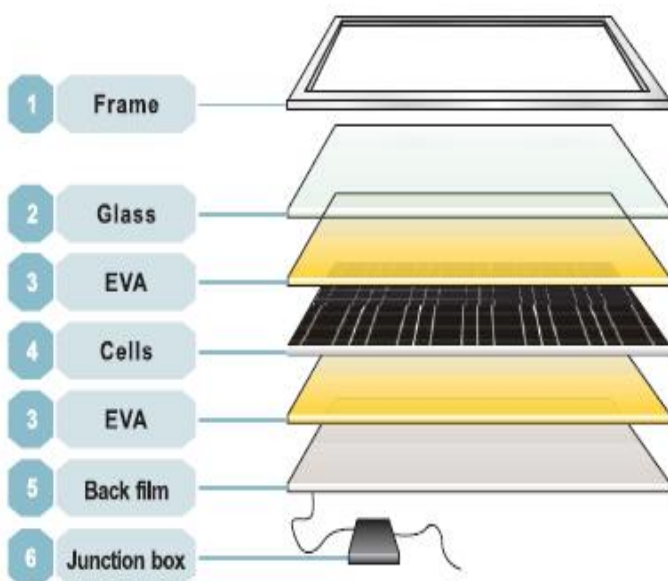

The Structure of Solar Modules

Cells

The hi-efficiency of mono and poly solar cells ensure adequate power for panels.

Glass

Low-iron tempered glass, 3.2mm thickness with higher reflectivity.

EVA

Higher transmission rate, antioxidant capacity and temperature resistance, no expansion or contraction.

Back film

Increase efficiency of modules slightly and reduce module's temperature. Aging resistance, corrosion resistance and airtight.

Aluminum Frame

Using the framework of the anodized aluminum frame with high intensity, mechanical shock resistance capacity.