

For a Free Quote:

Web: EnergyPal.com/solar

Call: 1-800-990-3725

Email: contact@energypal.com

EnergyPal

Solar Panel Guide Specification Data Sheet

Guangzhou Felicity Solar Technology Co., Ltd.

FL-P-100-310W

FL-P-210W

Also available on the web at

EnergyPal.com/guangzhou-felicity-solar-technology-co-ltd-solar-panels/fl-p-210w



SOLAR MODULE (POLY / MONO)

POLY-100W 18V / 155W 18.2V / 210W 36.6V / 260W 30.6V / 310W 36.8V
 MONO-100W 18V / 160W 18.2V / 210W 36.6V / 265W 30.6V / 320W 36.8V



Product features

Efficient polycrystalline modules are suitable for residential, public application areas, and can be widely used in the roof and ground electric power station projects.

Applying the most advanced module manufacturing technology with high output power. The maximum conversion rate is up to 16.39%.

Using anti-reflection glass, not only increases the absorption of light, but also strengthens its self-cleaning function when the modules are in the water environment, which can effectively reduce the power loss caused by dust.

Excellent low-light electricity generation performance.

Modules with strong compression capability, able to withstand 2400 Pa wind pressure and 5400 Pa snow load.

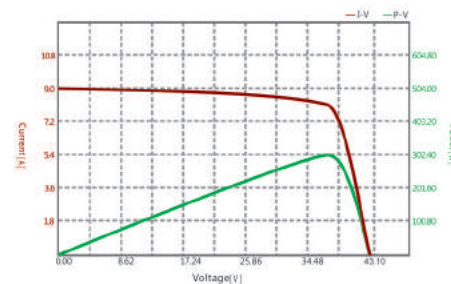

1. Highly transparent tempered glass
2. Encapsulant material - EVA
3. Photovoltaic solar cells
4. Encapsulant material - EVA
5. Insulating back sheet

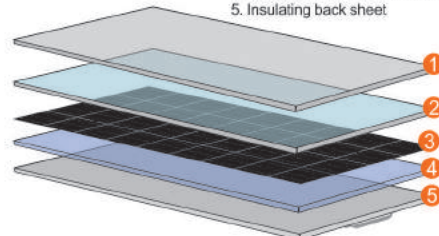

PRODUCT PARAMETERS

Type	Model	Standard Output Power (Watts)	Dimensions [mm]	Weight [Kg]	Maximum Power Voltage [Vmp]	Maximum Power Current [Imp]	Open-Circuit Voltage [Voc]	Short-Circuit Current [Isc]
POLY	FL-P-100W	100	1000*680*30	7.4	18V	5.56	21.6	5.89
POLY	FL-P-155W	155	1480*680*30	10.8	18.2V	8.52	21.84	9.03
POLY	FL-P-210W	210	1320*992*35	15.5	36.6V	5.74	43.92	6.10
POLY	FL-P-260W	260	1640*992*40	18.7	30.6V	8.50	36.72	9.01
POLY	FL-P-310W	310	1640*992*40	22.0	36.8V	8.43	44.16	8.93

PRODUCT PARAMETERS

Type	Model	Standard Output Power (Watts)	Dimensions [mm]	Weight [Kg]	Maximum Power Voltage [Vmp]	Maximum Power Current [Imp]	Open-Circuit Voltage [Voc]	Short-Circuit Current [Isc]
MONO	FL-P-100W	100	1195*540*30	7.14	18V	5.56	21.6	5.89
MONO	FL-P-160W	160	1480*680*30	10.8	18.2V	8.80	21.84	9.33
MONO	FL-P-210W	210	1580*808*35	15.5	36.6V	5.74	43.92	6.10
MONO	FL-P-265W	265	1640*992*40	18.7	30.6V	8.66	36.72	9.20
MONO	FL-P-320W	320	1640*992*40	22.0	36.8V	8.70	44.16	9.22

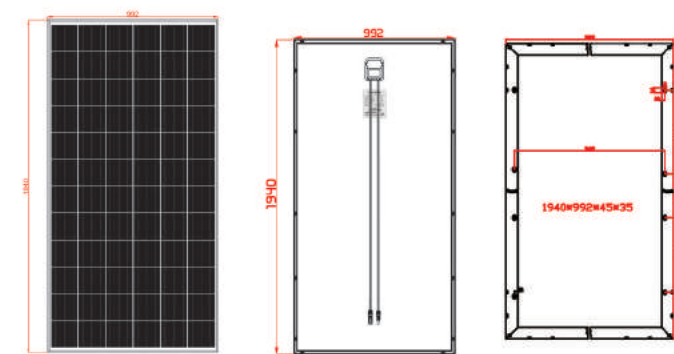

Engineering Drawing

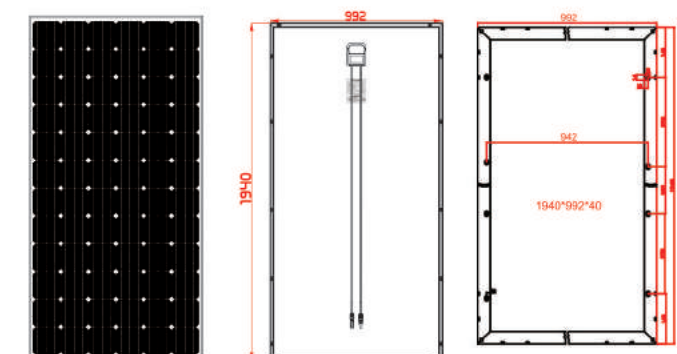

Engineering Drawing