

For a Free Quote:

Web: EnergyPal.com/solar

Call: 1-800-990-3725

Email: contact@energypal.com

EnergyPal

Solar Panel Guide Specification Data Sheet

**Heliene
HEE210U
HEE210WA68**

Also available on the web at
EnergyPal.com/heliene-solar-panels/hee210wa68

POLYCRYSTALLINE HEE210U 255 Watt

The solar module HEE210U is manufactured with high efficiency cells made by industry leading suppliers to guarantee a long lasting reliable power output. Robots allocate the 3 Bus Bar polycrystalline cells equally and interconnect the ribbon efficiently. The lightly textured glass of great optical transmission and diffused light collection covers the homogenous colored cells to create an esthetic module layout of high performance and quality design. The double reinforced anodized aluminum frame makes a rigid structure and flexible handling ideal for residential, commercial rooftop or ground mounted installations.

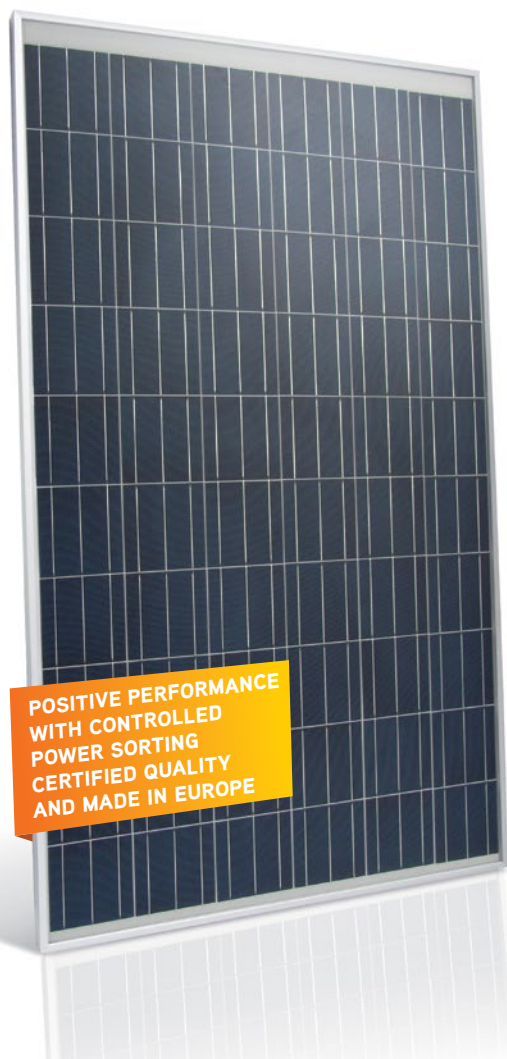

**HIGH
EFFICIENCY**



**FULL BLACK
(optional)**



3 BUS BAR



**RESISTANCE TO
ICE AND SNOW**



**LIGHTLY
TEXTURED GLASS**



**LOW IRRADIATION
CONDITION**



**PYRAMIDAL
GLASS (optional)**



60 CELLS



**4 mm GLASS
(optional)**



**HARD SOLDERED
JUNCTION BOX**



**12 YEAR
WARRANTY**



**5.400 Pa
LOADING CAPACITY**

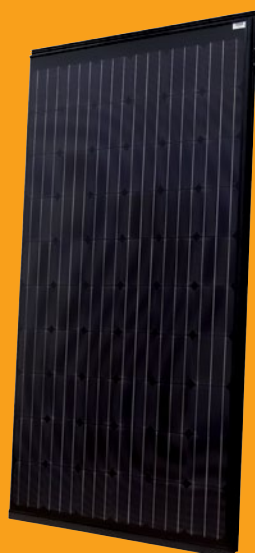

HIGH POWER OUTPUT

- 230-250 Wp. Wide range of output
- Homogeneous esthetics
- Maximum reliability

DIMENSIONS

Length x Width: 1680 x 990 mm
Thickness: 40mm
Weight: 22 kg

BIPV

Built in roof mounting systems providing maximum sealing.

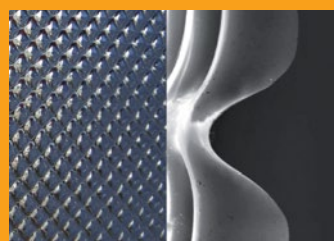

PYRAMIDAL GLASS

The pyramidal structure of solar glass ensures high production at low radiation conditions and reduces the reflection of incident light. At vertical installation the annual energy output is increased by 10%.

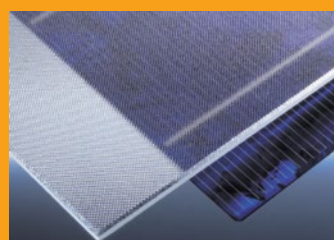

LIGHTLY TEXTURED GLASS

We use the lightly textured glass as our standard, which provides better properties on heat dissipation and reflection loss in comparison to plain usual solar glass.

SOLAR MODULE

HEE210U

255 Watt

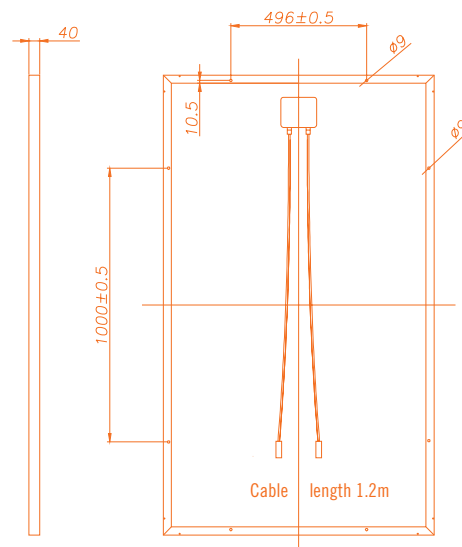
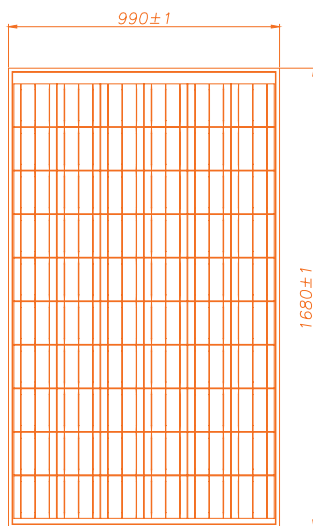
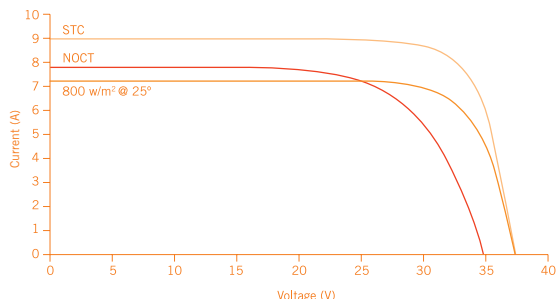

	HEE210UA69	HEE210UA68	HEE210UA67	HEE210UA66
POWER	255	250	245	240

STC (Standard Test Conditions)

Nominal power P_{MPP} (W)	255	250	245	240
Nominal voltage U_{MPP} (V)	30.95	30.7	30.43	30.35
Nominal current I_{MPP} (A)	8.20	8.14	8.05	7.91
Open circuit voltage V_{OC} (V)	37.90	37.8	37.65	37.55
Short circuit current I_{SC} (A)	8.71	8.65	8.56	8.55

STC: Irradiation 1000W/m² – Air mass AM 1.5 – Cell temperature 25°C

NOCT (Normal Operating Cell Temperature)

Nominal power P_{MPP} (W)	182	178	175	171
Nominal voltage U_{MPP} (V)	27.23	27.08	26.84	26.77
Nominal current I_{MPP} (A)	6.67	6.59	6.52	6.39
Open circuit voltage V_{OC} (V)	34.10	33.93	33.8	33.69
Short circuit current I_{SC} (A)	7.06	7.01	6.97	6.9

NOCT: Cell temperature in normal condition (= 45°) with Irradiation 800 W/m² – environmental temperature 20°C – Wind speed 1m/s.

ELECTRICAL AND THERMAL CHARACTERISTICS

System tension (V): 1000	Temp. Coeff. V_{OC} (%/°C) -0.32	Temp. Coeff. P_{MPP} (%/°C) -0.42
Reverse current (A): 12	Temp. Coeff. I_{SC} (%/°C) +0.07	Operating Temp. -40 till +85 °C

MECHANICAL FEATURES

Cells	60 in series, 3BB, 6"
Glass	Lightly textured, high transparency, anti-reflective, hardened
Back sheet	Multi-layer lamination PVF and PET
Frame	Anodized aluminum in standard module / BIPV assembling
Connection	2x1.1m of cable, MC4 type connectors
Junction box	Protection index IP65, 3 diodes by-pass

MEASURING TOLERANCES Pmax: +/-3%

Warranty: 12 years for manufacturing defects and 80% nominal power at 25 years

Any additional information can be supplied under request



Friendly to Environment.

Our packaging decomposition is biological and totally degradable.

Specifications are subject to change without notice. HELIOS ENERGY EUROPE S.L. (HELIENE) 05/2014

HELIOS ENERGY EUROPE S.L.

Worldwide Headquarters
Manufacturing and Sales

Pza. del Xarol, 13-15
Pol. Ind. Les Guixeres
08915 BADALONA (Barcelona)
SPAIN
PH. +34 93 313 61 62
info@heliosenergy.es
www.heliosenergy.es

HELIENE Inc

Manufacturing and Sales

520 Allen's Side Rd
Sault Ste. Marie, ON
CANADA
www.heliene.ca

HELIOS USA

Manufacturing and Sales

1301 W Canal St.
Milwaukee, WI 53233
USA
www.helios-usa.com

BIOSOLAR

Sales and Distribution

Opstalstraat, 21
B-9620 Zottegem
BELGIUM
PH. +32 (0)9 349 36 20
FAX. +32 (0)9 349 36 21

www.heliene.nl
www.heliene.be

BAES

Sales and Distribution

Block-D, Road 31,
House-20, Shahjalal Upashahar
Sylhet-3100, Bangladesh
PH. 0821-712848

www.baes-ltd.com