

For a Free Quote:

Web: EnergyPal.com/solar

Call: 1-800-990-3725

Email: contact@energypal.com

EnergyPal

Solar Panel Guide Specification Data Sheet

**Hefei Rosen Solar Energy Co., Ltd.
RS36P Black Series
RS170P-36**

Also available on the web at
EnergyPal.com/hefei-rosen-solar-energy-co-ltd-solar-panels/rs170p-36



Rosen Solar

To light up the world

Alibaba TOP 3 Suppliers
Trade Assurance Supplier

Verified Alibaba Supplier

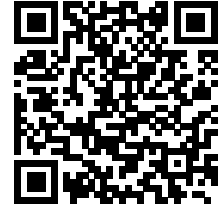

RS96M Series

Monocrystalline 96cells
Power Range: 440-500W



Key Features



Monocrystalline modules designed for commercial and solar farm grid-tied applications



High power output and highest conversion efficiency



Anti-reflective and anti-soiling surface reduces power loss from dirt and dust



Outstanding performance in low-light irradiance environments



Excellent mechanical load resistance: Certified to withstand high wind loads (2400Pa) and snow loads (5400Pa)



High salt and ammonia resistance certified by TÜV NORD

Superior Warranty

- 10-year product warranty
- 25-year linear power output warranty

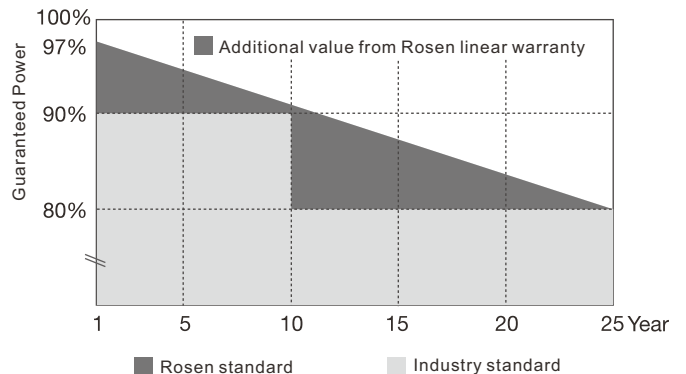

Reliable Quality

- Positive power tolerance: 0~+5W
- 100% EL double-inspection ensures modules are defects free
- Modules binned by current to improve system performance
- Potential Induced Degradation(PID) Resistant

RS96M Series

Monocrystalline 96 cells

Power Range: 440-500W

Mechanical Data

Solar Cells	Mono 156*156mm, 5BB
Cell Orientation	96cells (8*12)
Module Dimensions	1956*1310*45mm
Weight	26kg (Approx)
Glass	3.2mm, High Transmission, AR Coated Tempered Glass
J-Box	IP67 or IP68 rated
Cables	Photovoltaic Technology Cable 4.0mm ² , 900mm
Connector	MC4/UTX/TSA/QC4*

Working Conditions

Maximum System Voltage	1000 V DC (IEC)
Operational Temperature	-40~ +85°C
Max Series Fuse Rating	15A
NOCT	44°C(±2°C)
Application Class	Class A
Packaging Configuration	Modules per pallet: 23 pieces Modules per 40' container: 474 pieces

Dimensions of PV Module(mm)

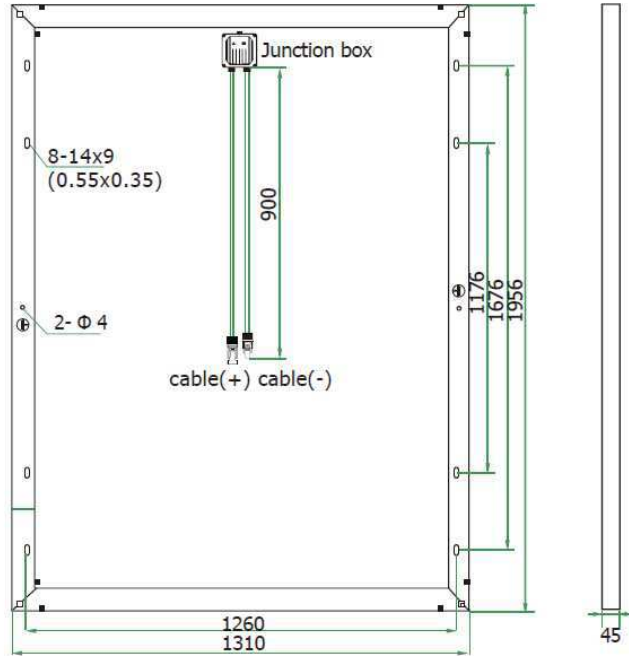

Electrical Data(STC)

Module	RS440M-96	RS450M-96	RS460M-96	RS470M-96	RS480M-96	RS490M-96	RS500M-96
Peak Power Watts-Pmax(Wp)*	440	450	460	470	480	490	500
Maximum Power Voltage-Vmpp(V)	47.78	47.88	48.02	48.11	48.35	48.45	48.63
Maximum Power Current-Imp(A)	9.21	9.40	9.60	9.79	9.93	10.12	10.29
Open Circuit Voltage-Voc(V)	58.50	58.57	58.75	58.82	58.89	58.95	59.01
Short Circuit Current-Isc(A)	9.40	9.73	9.78	9.90	10.04	10.67	10.87
Module Efficiency (%)	17.17	17.56	17.95	18.34	18.73	19.12	19.51
Power Output Tolerance-Pmax(W)	0 ~+5						
Temperature Coefficient of Pmax	-0.410%/°C						
Temperature Coefficient of Voc	-0.330%/°C						
Temperature Coefficient of Isc	0.058%/°C						
STC	Irradiance 1000W/m ² , Cell Temperature 25°C, Air Mass AM1.5						

I-V Curve

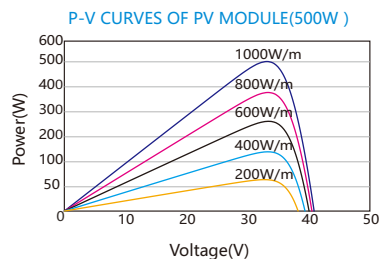
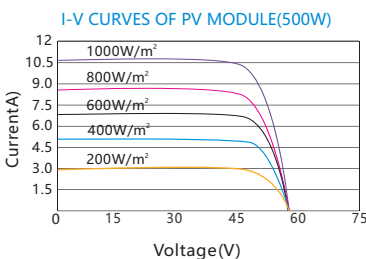

Appearance Color

Back sheet	White
Frame	Sliver Anodized Aluminium Alloy



Rosen Solar

To light up the world

Alibaba TOP 3 Suppliers
Trade Assurance Supplier

Verified Alibaba Supplier

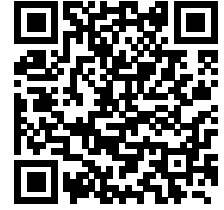

RS72M Series

Monocrystalline 72cells

Power Range: 340-380W

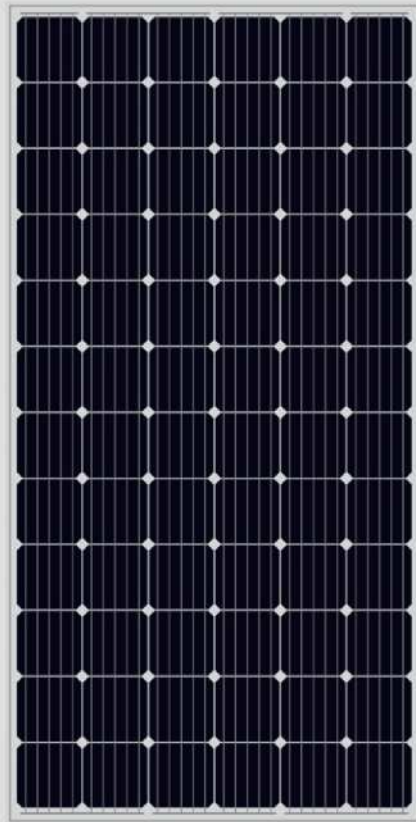

Key Features



Monocrystalline modules designed for commercial and solar farm grid-tied applications



High power output and highest conversion efficiency



Anti-reflective and anti-soiling surface reduces power loss from dirt and dust



Outstanding performance in low-light irradiance environments



Excellent mechanical load resistance: Certified to withstand high wind loads (2400Pa) and snow loads (5400Pa)



High salt and ammonia resistance certified by TÜV NORD

Superior Warranty

- 10-year product warranty
- 25-year linear power output warranty

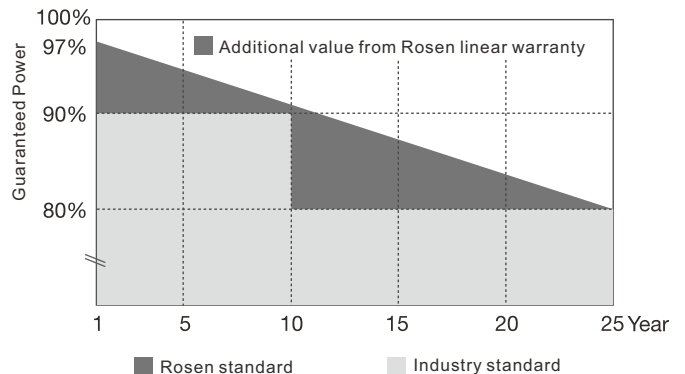

Reliable Quality

- Positive power tolerance: 0~+5W
- 100% EL double-inspection ensures modules are defects free
- Modules binned by current to improve system performance
- Potential Induced Degradation(PID) Resistant

RS72M Series

Monocrystalline 72 cells

Power Range: 340-380W

Mechanical Data

Solar Cells	Mono 156*156mm, 5BB
Cell Orientation	72cells (6*12)
Module Dimensions	1956*992*40mm
Weight	22kg (Approx)
Glass	3.2mm, High Transmission, AR Coated Tempered Glass
J-Box	IP67 or IP68 rated
Cables	Photovoltaic Technology Cable 4.0mm ² , 900mm
Connector	MC4/UTX/TS4/QC4*

Working Conditions

Maximum System Voltage	1000 V DC (IEC)
Operational Temperature	-40~ +85°C
Max Series Fuse Rating	20A
NOCT	44°C(±2°C)
Application Class	Class A
Packaging Conginguration	Modules per pallet:27 pieces Modules per 40' container: 720 pieces

Dimensions of PV Module(mm)

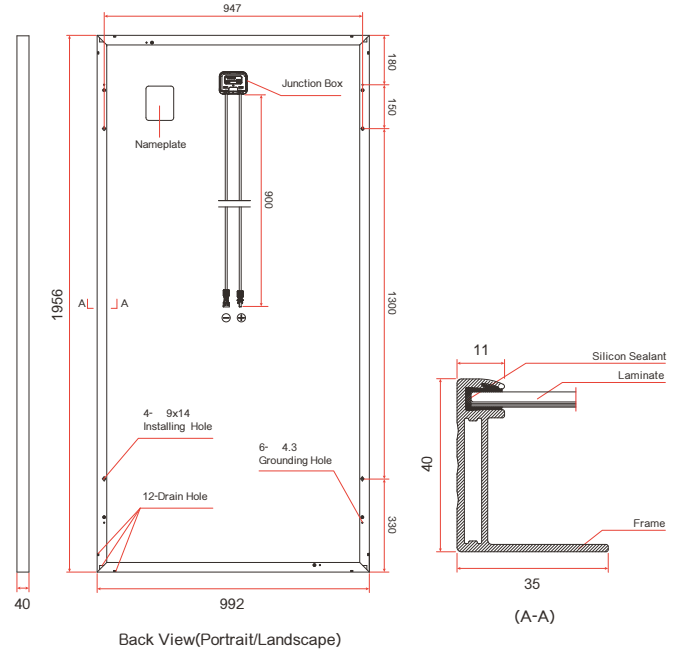

Electrical Data(STC)

Module	RS340M-72	RS345M-72	RS350M-72	RS355M-72	RS360M-72	RS365M-72	RS370M-72	RS375M-72	RS380M-72
Peak Power Watts-Pmax(Wp)*	340	345	350	355	360	365	370	375	380
Maximum Power Voltage-Vmpp(V)	38.2	38.5	38.7	38.9	39.0	39.3	39.7	40.0	40.4
Maximum Power Current-Impp(A)	8.91	8.97	9.05	9.14	9.24	9.30	9.33	9.38	9.41
Open Circuit Voltage-Voc(V)	46.2	46.7	47.0	47.4	47.7	48.0	48.3	48.5	48.8
Short Circuit Current-Isc(A)	9.5	9.55	9.60	9.65	9.70	9.77	9.83	9.88	9.93
Module Efficiency (%)	17.5	17.7	18.0	18.3	18.5	18.8	19.0	19.3	19.5
Power Output Tolerance-Pmax(W)	0 ~+5								
Temperature Coefficient of Pmax	-0.39%/°C								
Temperature Coefficient of Voc	-0.29%/°C								
Temperature Coefficient of Isc	0.05%/°C								

STC Irradiance 1000W/m², Cell Temperature 25°C, Air Mass AM1.5

I-V Curve

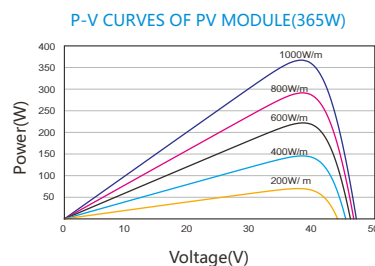
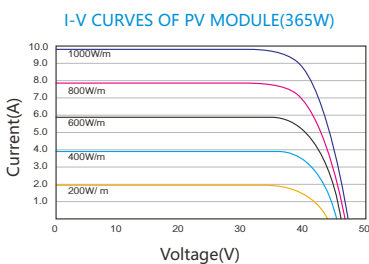

Appearance Color

Back sheet	White
Frame	Sliver Anodized Aluminium Alloy



Rosen Solar

To light up the world

Alibaba TOP 3 Suppliers
Trade Assurance Supplier

Verified Alibaba Supplier

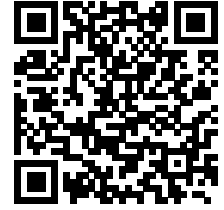

RS72P Series

Polycrystalline 72cells

Power Range: 330-360W

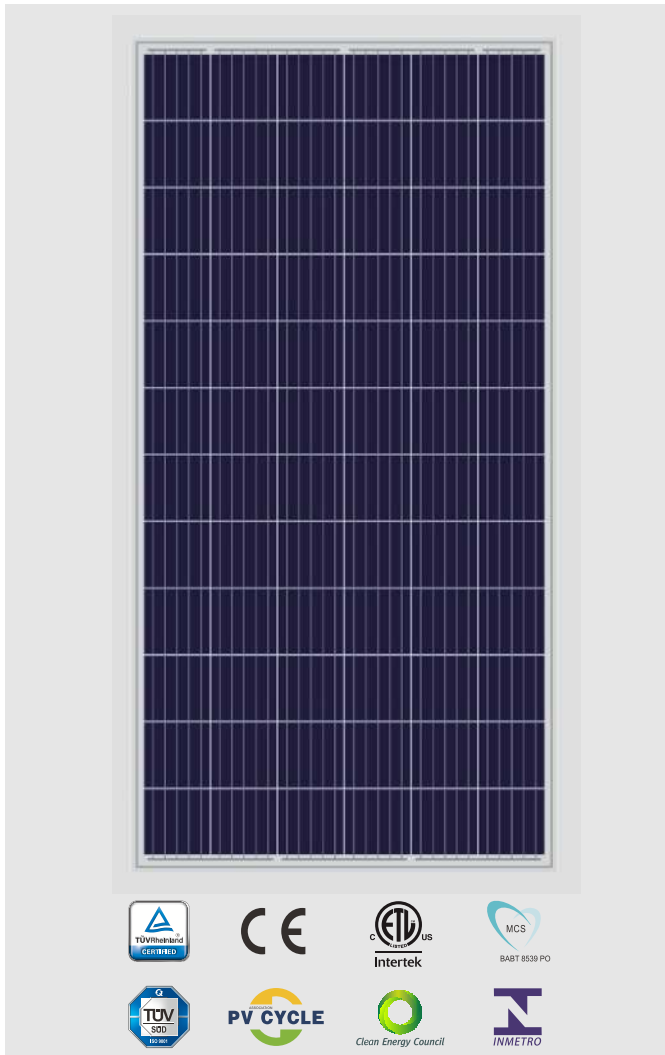

Key Features



Monocrystalline modules designed for commercial and solar farm grid-tied applications



High power output and highest conversion efficiency



Anti-reflective and anti-soiling surface reduces power loss from dirt and dust



Outstanding performance in low-light irradiance environments



Excellent mechanical load resistance: Certified to withstand high wind loads (2400Pa) and snow loads (5400Pa)



High salt and ammonia resistance certified by TÜV NORD

Superior Warranty

- 10-year product warranty
- 25-year linear power output warranty

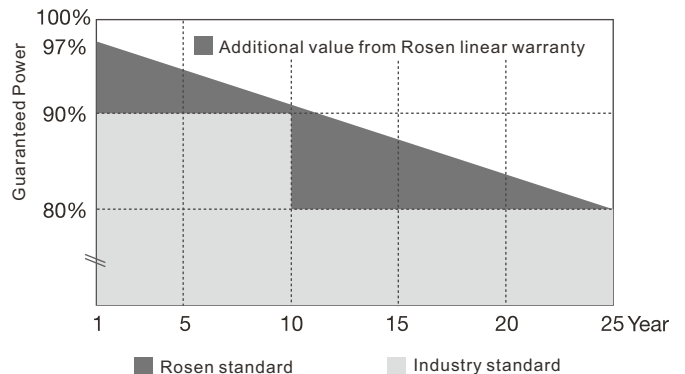

Reliable Quality

- Positive power tolerance: 0~+5W
- 100% EL double-inspection ensures modules are defects free
- Modules binned by current to improve system performance
- Potential Induced Degradation(PID) Resistant

RS72P Series

Polycrystalline 72 cells
Power Range: 330-360W

Mechanical Data

Solar Cells	Poly 156*156mm, 5BB
Cell Orientation	72cells (6*12)
Module Dimensions	1956*992*40mm
Weight	22kg (Approx)
Glass	3.2mm, High Transmission, AR Coated Tempered Glass
J-Box	IP67 or IP68 rated
Cables	Photovoltaic Technology Cable 4.0mm ² , 900mm
Connector	MC4/UTX/TS4/QC4*

Working Conditions

Maximum System Voltage	1000 V DC (IEC)
Operational Temperature	-40~ +85°C
Max Series Fuse Rating	15A
NOCT	44°C(±2°C)
Application Class	Class A
Packaging Conginguration	Modules per pallet: 27 pieces Modules per 40' container: 720 pieces

Dimensions of PV Module(mm)

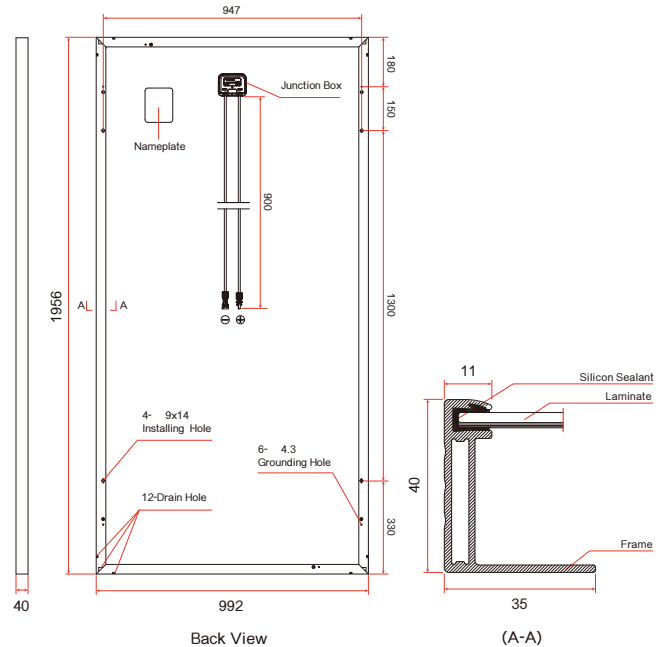

Electrical Data(STC)

Module	RS330P-72	RS335P-72	RS340P-72	RS345P-72	RS350P-72	RS355P-72	RS360P-72
Peak Power Watts-Pmax(Wp)*	330	335	340	345	350	355	360
Maximum Power Voltage-Vmpp(V)	37.4	37.6	37.8	38.1	38.3	38.5	38.7
Maximum Power Current-Impp(A)	8.83	8.91	9.00	9.07	9.16	9.24	9.32
Open Circuit Voltage-Voc(V)	45.8	46.0	46.2	46.4	46.5	46.7	46.9
Short Circuit Current-Isc(A)	9.28	9.35	9.42	9.50	9.57	9.65	9.72
Module Efficiency (%)	17.0	17.2	17.5	17.8	18.0	18.3	18.5
Power Output Tolerance-Pmax(W)	0 ~+5						
Temperature Coefficient of Pmax	-0.41%/°C						
Temperature Coefficient of Voc	-0.32%/°C						
Temperature Coefficient of Isc	0.05%/°C						

STC Irradiance 1000W/m², Cell Temperature 25°C, Air Mass AM1.5

I-V Curve

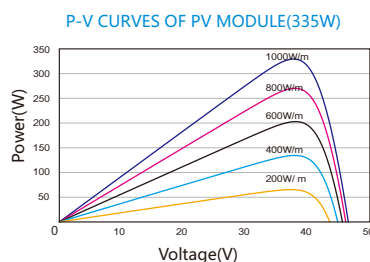
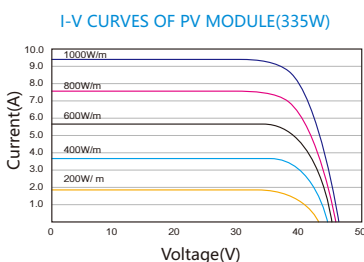

Appearance Color

Back sheet	White
Frame	Sliver Anodized Aluminium Alloy



Rosen Solar

To light up the world

Alibaba TOP 3 Suppliers
Trade Assurance Supplier

Verified Alibaba Supplier

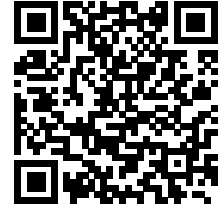

RS60M Series

Monocrystalline 60cells
Power Range: 275-315W



Key Features



Monocrystalline modules designed for commercial and solar farm grid-tied applications



High power output and highest conversion efficiency



Anti-reflective and anti-soiling surface reduces power loss from dirt and dust



Outstanding performance in low-light irradiance environments



Excellent mechanical load resistance: Certified to withstand high wind loads (2400Pa) and snow loads (5400Pa)



High salt and ammonia resistance certified by TÜV NORD

Superior Warranty

- 10-year product warranty
- 25-year linear power output warranty

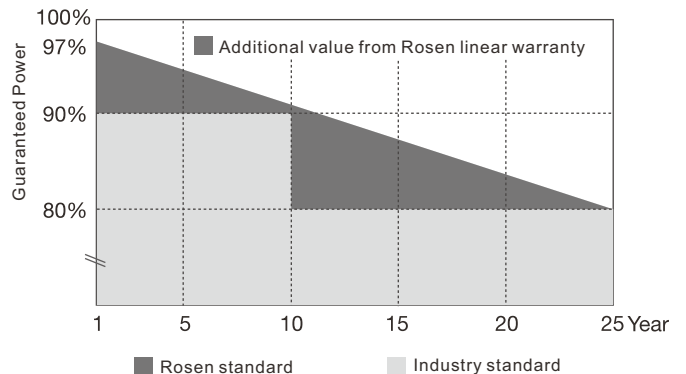

Reliable Quality

- Positive power tolerance: 0~+5W
- 100% EL double-inspection ensures modules are defects free
- Modules binned by current to improve system performance
- Potential Induced Degradation(PID) Resistant

RS60M Series

Monocrystalline 60 cells

Power Range: 275-315W

Mechanical Data

Solar Cells	Mono 156*156mm,5BB
Cell Orientation	60cells (6*10)
Module Dimensions	1640*992*35mm
Weight	18kg (Approx)
Glass	3.2mm, High Transmission, AR Coated Tempered Glass
J-Box	IP67 or IP68 rated
Cables	Photovoltaic Technology Cable 4.0mm ² , 900mm
Connector	MC4/UTX/TS4/QC4*

Working Conditions

Maximum System Voltage	1000 V DC (IEC)
Operational Temperature	-40~ +85°C
Max Series Fuse Rating	15A
NOCT	44°C(±2°C)
Application Class	Class A
Packaging Configuration	Modules per pallet: 30 pieces Modules per 40' container: 910 pieces

Dimensions of PV Module(mm)

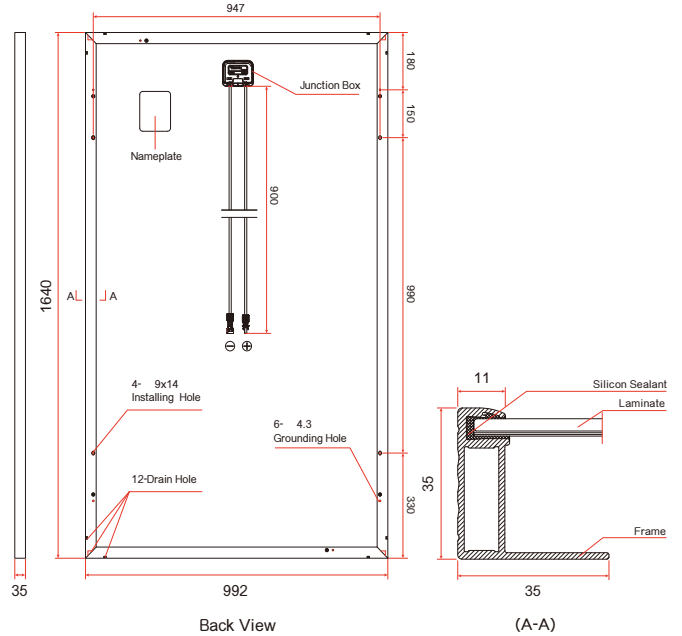

Electrical Data(STC)

Module	RS275M-60	RS280M-60	RS285M-60	RS290M-60	RS295M-60	RS300M-60	RS305M-60	RS310M-60	RS315M-60
Peak Power Watts-Pmax(Wp)*	275	280	285	290	295	300	305	310	315
Maximum Power Voltage-Vmpp(V)	31.4	31.7	31.8	32.2	32.5	32.7	32.9	33.1	33.3
Maximum Power Current-Impp(A)	8.76	8.84	8.97	9.01	9.08	9.19	9.28	9.37	9.46
Open Circuit Voltage-Voc(V)	38.4	38.4	38.5	38.9	39.6	39.8	40.0	40.2	40.5
Short Circuit Current-Isc(A)	9.24	9.42	9.51	9.66	9.68	9.77	9.85	9.94	10.0
Module Efficiency (%)	16.8	17.1	17.4	17.7	18.0	18.3	18.5	18.9	19.2
Power Output Tolerance-Pmax(W)	0 ~+5								
Temperature Coefficient of Pmax	-0.39%/°C								
Temperature Coefficient of Voc	-0.29%/°C								
Temperature Coefficient of Isc	0.05%/°C								
STC	Irradiance 1000W/m ² , Cell Temperature 25°C, Air Mass AM1.5								

I-V Curve

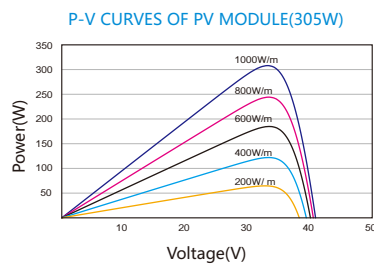
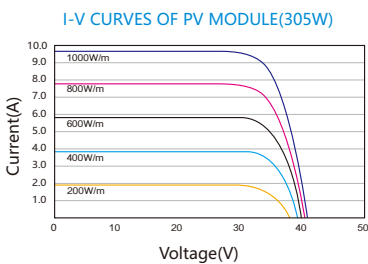

Appearance Color

Back sheet	White
Frame	Sliver Anodized Aluminium Alloy



Rosen Solar

To light up the world

Alibaba TOP 3 Suppliers
Trade Assurance Supplier

Verified Alibaba Supplier



RS60P Series

Polycrystalline 60cells

Power Range: 265-285W



Key Features



Polycrystalline modules designed for commercial and solar farm grid-tied applications



High power output and highest conversion efficiency



Anti-reflective and anti-soiling surface reduces power loss from dirt and dust



Outstanding performance in low-light irradiance environments



Excellent mechanical load resistance: Certified to withstand high wind loads (2400Pa) and snow loads (5400Pa)



High salt and ammonia resistance certified by TÜV NORD

Superior Warranty

- 10-year product warranty
- 25-year linear power output warranty

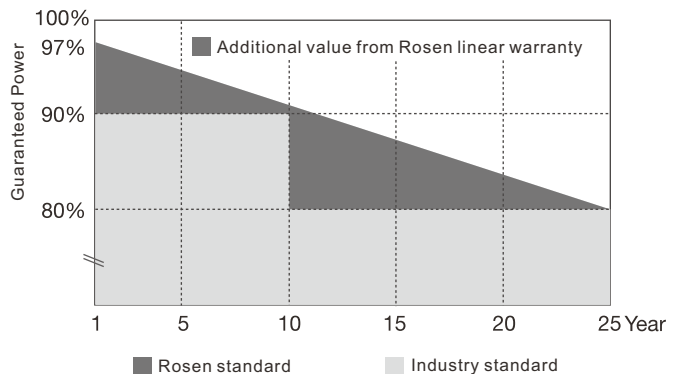

Reliable Quality

- Positive power tolerance: 0~+5W
- 100% EL double-inspection ensures modules are defects free
- Modules binned by current to improve system performance
- Potential Induced Degradation(PID) Resistant



RS60P Series

Polycrystalline 60 cells
Power Range: 265-285W



Mechanical Data

Solar Cells	Poly 156*156mm,5BB
Cell Orientation	60cells (6*10)
Module Dimensions	1640*992*35mm
Weight	18kg (Approx)
Glass	3.2mm, High Transmission, AR Coated Tempered Glass
J-Box	IP67 or IP68 rated
Cables	Photovoltaic Technology Cable 4.0mm ² , 900mm
Connector	MC4/UTX/TS4/QC4*

Working Conditions

Maximum System Voltage	1000 V DC (IEC)
Operational Temperature	-40~ +85°C
Max Series Fuse Rating	15A
NOCT	44°C(±2°C)
Application Class	Class A
Packaging Configuration	Modules per pallet: 30 pieces Modules per 40' container: 910 pieces

Dimensions of PV Module(mm)

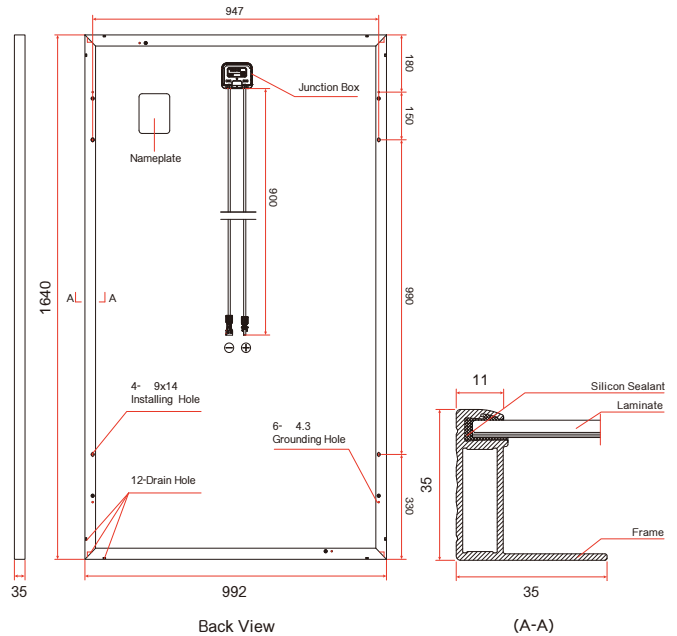

Electrical Data(STC)

Module	RS265P-60	RS270P-60	RS275P-60	RS280P-60	RS285P-60
Peak Power Watts-Pmax(Wp)*	265	270	275	280	285
Maximum Power Voltage-Vmpp(V)	30.8	31.0	31.1	31.4	31.6
Maximum Power Current-Impp(A)	8.61	8.73	8.85	8.92	9.02
Open Circuit Voltage-Voc(V)	37.7	37.9	38.1	38.2	38.3
Short Circuit Current-Isc(A)	9.15	9.22	9.32	9.40	9.49
Module Efficiency (%)	16.2	16.5	16.8	17.1	17.4
Power Output Tolerance-Pmax(W)			0 ~+5		
Temperature Coefficient of Pmax			-0.41%/°C		
Temperature Coefficient of Voc			-0.32%/°C		
Temperature Coefficient of Isc			0.05%/°C		

STC Irradiance 1000W/m², Cell Temperature 25°C, Air Mass AM1.5

I-V Curve

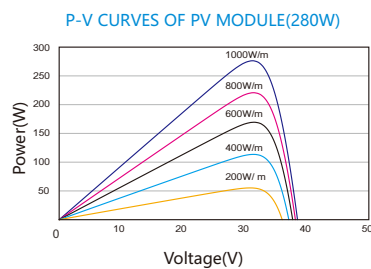
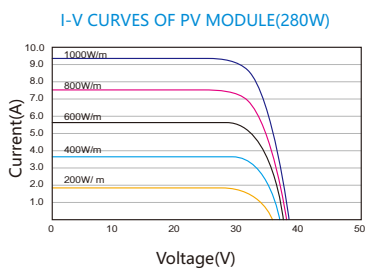

Appearance Color

Back sheet	White
Frame	Sliver Anodized Aluminium Alloy



Rosen Solar

To light up the world

Alibaba TOP 3 Suppliers
Trade Assurance Supplier

Verified Alibaba Supplier

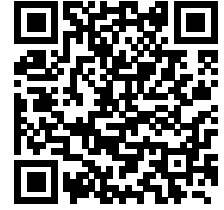

RS36M Series

Monocrystalline 36cells
Power Range: 170-190W

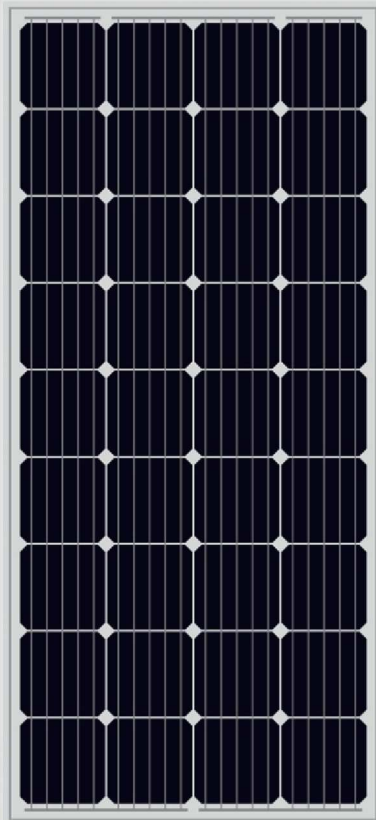

Key Features



Monocrystalline modules designed for commercial and solar farm grid-tied applications



High power output and highest conversion efficiency



Anti-reflective and anti-soiling surface reduces power loss from dirt and dust



Outstanding performance in low-light irradiance environments



Excellent mechanical load resistance: Certified to withstand high wind loads (2400Pa) and snow loads (5400Pa)



High salt and ammonia resistance certified by TÜV NORD

Superior Warranty

- 10-year product warranty
- 25-year linear power output warranty

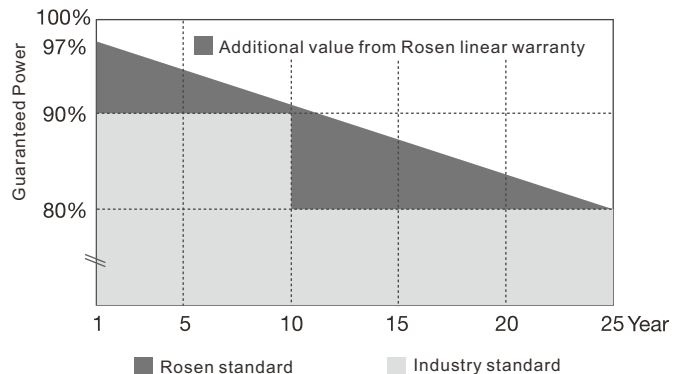

Reliable Quality

- Positive power tolerance: 0~+5W
- 100% EL double-inspection ensures modules are defects free
- Modules binned by current to improve system performance
- Potential Induced Degradation(PID) Resistant

RS36M Series

Monocrystalline 36 cells

Power Range: 170-190W

Mechanical Data

Solar Cells	Mono 156*156mm, 5BB
Cell Orientation	36cells (4*9)
Module Dimensions	1480*676*30mm
Weight	10.6kg (Approx)
Glass	3.2mm, High Transmission, AR Coated Tempered Glass
J-Box	IP67 or IP68 rated
Cables	Photovoltaic Technology Cable 4.0mm ² , 900mm
Connector	MC4/UTX/TS4/QC4*

Working Conditions

Maximum System Voltage	1000 V DC (IEC)
Operational Temperature	-40~ +85°C
Max Series Fuse Rating	15A
NOCT	44°C(±2°C)
Application Class	Class A
Packaging Conginguration	Modules per pallet: 35pcs Modules per 40' container: 1600pcs

Dimensions of PV Module(mm)

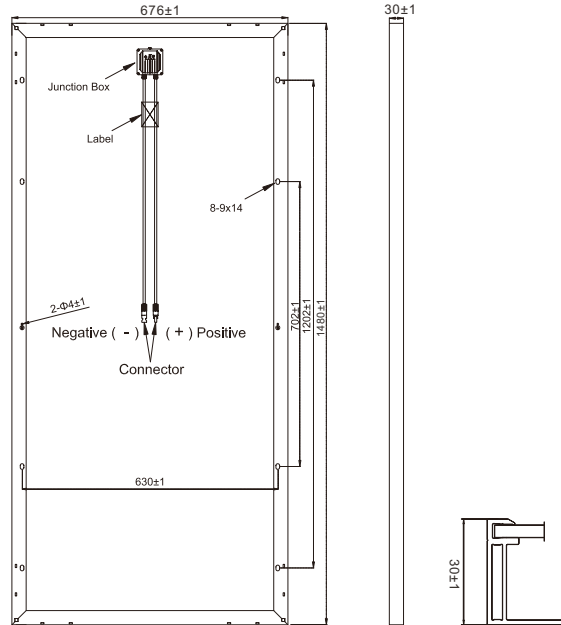

Electrical Data(STC)

Module	RS170M-36	RS175M-36	RS180M-36	RS185M-36	RS190M-36
Peak Power Watts-Pmax(Wp)*	170	175	180	185	190
Maximum Power Voltage-Vmpp(V)	17.9	18.0	18.1	18.2	18.3
Maximum Power Current-Impp(A)	9.50	9.73	9.95	10.17	10.39
Open Circuit Voltage-Voc(V)	22.8	22.9	23.0	23.1	23.2
Short Circuit Current-Isc(A)	9.74	9.98	9.94	10.46	10.70
Module Efficiency (%)	17.08	17.58	18.09	18.59	19.9
Power Output Tolerance-Pmax(W)			0 ~+5		
Temperature Coefficient of Pmax			-0.41%/°C		
Temperature Coefficient of Voc			-0.33%/°C		
Temperature Coefficient of Isc			0.059%/°C		

STC Irradiance 1000W/m², Cell Temperature 25°C, Air Mass AM1.5

I-V Curve

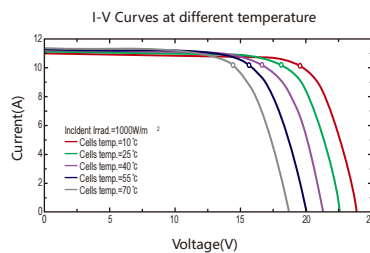
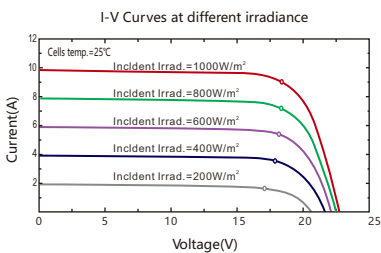

Appearance Color

Back sheet	White
Frame	Sliver Anodized Aluminium Alloy



Rosen Solar

To light up the world

Alibaba TOP 3 Suppliers
Trade Assurance Supplier

Verified Alibaba Supplier

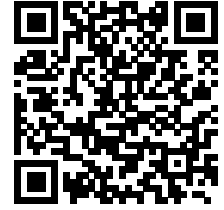

RS36P Series

Polycrystalline 36cells

Power Range: 155-175W

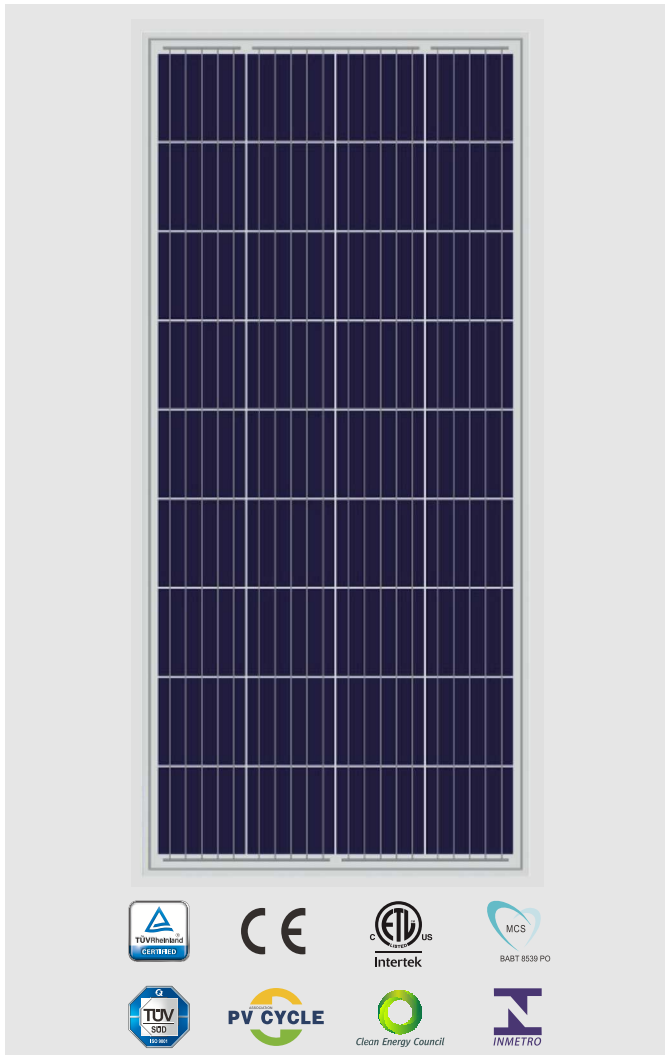

Key Features



Monocrystalline modules designed for commercial and solar farm grid-tied applications



High power output and highest conversion efficiency



Anti-reflective and anti-soiling surface reduces power loss from dirt and dust



Outstanding performance in low-light irradiance environments



Excellent mechanical load resistance: Certified to withstand high wind loads (2400Pa) and snow loads (5400Pa)



High salt and ammonia resistance certified by TÜV NORD

Superior Warranty

- 10-year product warranty
- 25-year linear power output warranty

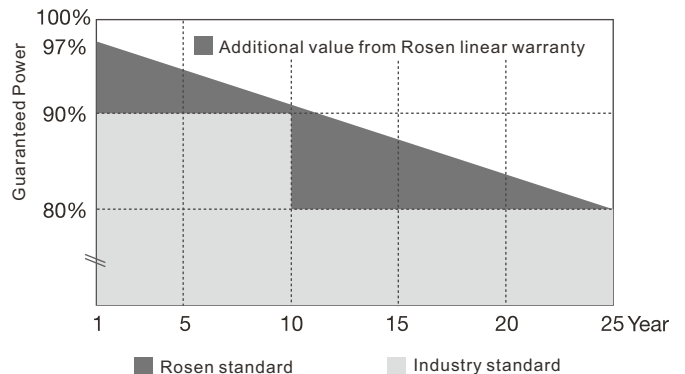

Reliable Quality

- Positive power tolerance: 0~+5W
- 100% EL double-inspection ensures modules are defects free
- Modules binned by current to improve system performance
- Potential Induced Degradation(PID) Resistant

RS36P Series

Polycrystalline 36 cells
Power Range: 155-175W

Mechanical Data

Solar Cells	Poly 156*156mm, 5BB
Cell Orientation	36cells (4*9)
Module Dimensions	1480*676*30mm
Weight	10.6kg (Approx)
Glass	3.2mm, High Transmission, AR Coated Tempered Glass
J-Box	IP67 or IP68 rated
Cables	Photovoltaic Technology Cable 4.0mm ² , 900mm
Connector	MC4/UTX/TS4/QC4*

Dimensions of PV Module(mm)

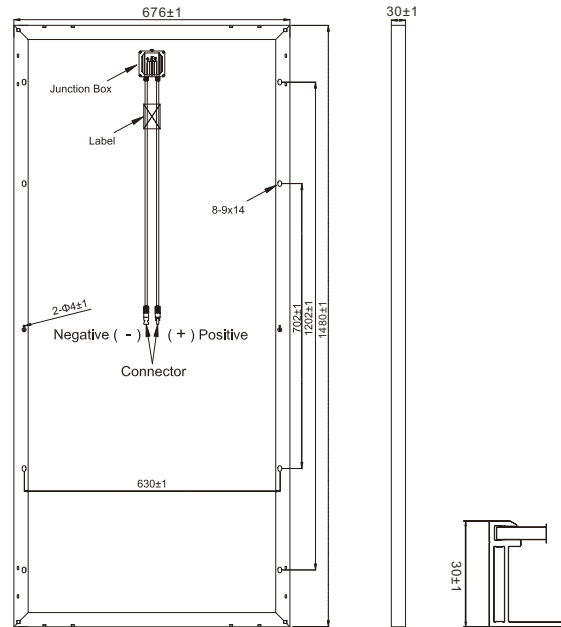

Working Conditions

Maximum System Voltage	1000 V DC (IEC)
Operational Temperature	-40~ +85°C
Max Series Fuse Rating	15A
NOCT	44°C(±2°C)
Application Class	Class A
Packaging Configuration	Modules per pallet: 35pcs Modules per 40' container: 1600pcs

Electrical Data(STC)

Module	RS155P-36	RS160P-36	RS165P-36	RS170P-36	RS175P-36
Peak Power Watts-Pmax(Wp)*	155	160	165	170	175
Maximum Power Voltage-Vmpp(V)	17.6	17.7	17.8	17.9	18.00
Maximum Power Current-Impp(A)	8.81	9.04	9.27	9.50	9.73
Open Circuit Voltage-Voc(V)	22.5	22.6	22.7	22.8	22.9
Short Circuit Current-Isc(A)	9.05	9.25	9.55	9.74	9.98
Module Efficiency (%)	15.57	16.08	16.58	17.09	17.58
Power Output Tolerance-Pmax(W)			0 ~+5		
Temperature Coefficient of Pmax			-0.41%/°C		
Temperature Coefficient of Voc			-0.33%/°C		
Temperature Coefficient of Isc			0.059%/°C		

STC Irradiance 1000W/m², Cell Temperature 25°C, Air Mass AM1.5

I-V Curve

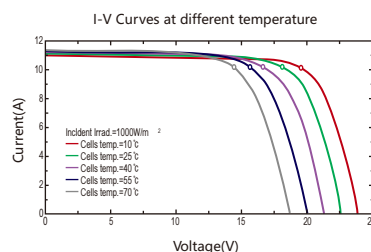
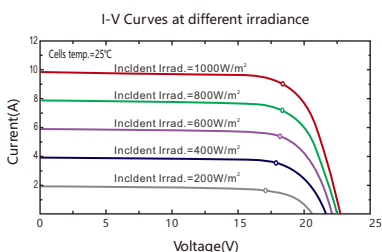

Appearance Color

Back sheet	White
Frame	Sliver Anodized Aluminium Alloy



Rosen Solar

To light up the world

Alibaba TOP 10 Suppliers
Trade Assurance Supply
Verified Supplier

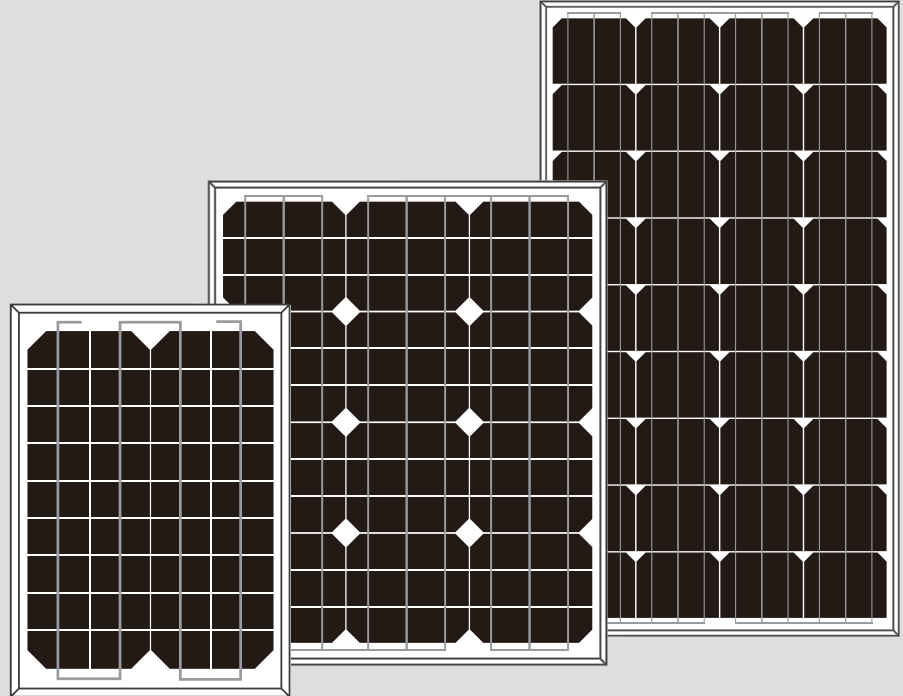

MONO SOLAR PANEL

36 CELLS 5W-120W

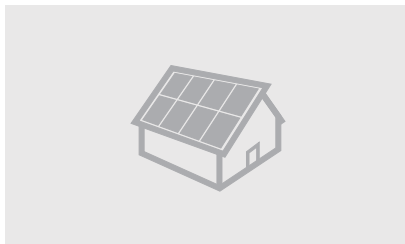

Specially design for off grid application



Outstanding performance



Positive power tolerance:0~+5w

WARRANTIES

10 years for product defects in materials & workmanship

10 years for 90% of warranted minimum power output

25 years for 80% of warranted minimum power output

25 years linear warranty

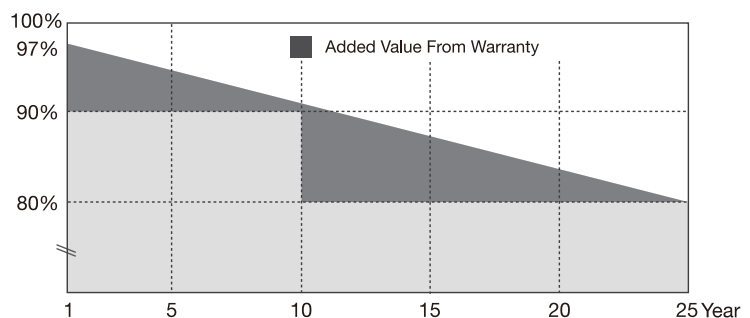

M36PCS(MONO) 70W~120W

PRODUCT SPECIFICATION

Model type	120W	100W	90W	85W	80W	70W
Peak power(Pmax)	120	100	90	85	80	70
Weight(kg)	10	8.45	7.76	7.35	7.02	6.29
Dimensions(mm)	1280x670x35	1070x670x35	975x670x35	920x670x35	875x670x35	775x670x35
Maximum power voltage (Vmp)	17.5	17.5	17.5	17.5	17.5	17.5
Maximum power current (Imp)	6.86	5.72	5.143	4.86	4.58	4
Open circuit voltage (Voc)	21.6	21.6	21.6	21.6	21.6	21.6
Short circuit current (Isc)	7.75	6.46	5.81	5.49	5.17	4.52
Maximum system voltage	DC 1000V					
Temp.Coeff.of Isc(TK Isc)	0.045%/°C					
Temp.Coeff.of Voc(TK Voc)	-0.34%/°C					
Temp.Coeff.of Pmax(TK Pmax)	-0.47%/°C					
Normal Operting Cell Temperature	45±2°C					
Tolerance	0- +5W					

M36PCS(MONO) 30W~60W

PRODUCT SPECIFICATION

Model type	60W	50W	40W	30W
Peak power(Pmax)	60	50	40	30
Weight(kg)	5.52	4.82	4.09	3.36
Dimensions(mm)	675x670x30	580x670x30	480x670x30	380x670x30
Maximum power voltage (Vmp)	17.5	17.5	17.5	17.5
Maximum power current (Imp)	3.43	2.86	2.29	1.72
Open circuit voltage (Voc)	21.6	21.6	21.6	21.6
Short circuit current (Isc)	3.87	3.23	2.59	1.93
Maximum system voltage	DC 1000V			
Temp.Coeff.of Isc(TK Isc)	0.045%/°C			
Temp.Coeff.of Voc(TK Voc)	-0.34%/°C			
Temp.Coeff.of Pmax(TK Pmax)	-0.47%/°C			
Normal Operting Cell Temperature	45±2°C			
Tolerance	0- +5W			

M36PCS(MONO) 5W~20W

PRODUCT SPECIFICATION

Model type	20W	15W	10W	5W
Peak power(Pmax)	20	15	10	5
Weight(kg)	2.11	1.71	1.09	0.73
Dimensions(mm)	475x350x25	375x350x25	270x350x17	170x350x17
Maximum power voltage (Vmp)	17.5	17.5	17.5	17.5
Maximum power current (Imp)	1.15	0.86	0.58	0.29
Open circuit voltage (Voc)	21.6	21.6	21.6	21.6
Short circuit current (Isc)	1.3	0.97	0.65	0.33
Maximum system voltage	DC 1000V			
Temp.Coeff.of Isc(TK Isc)	0.045%/°C			
Temp.Coeff.of Voc(TK Voc)	-0.34%/°C			
Temp.Coeff.of Pmax(TK Pmax)	-0.47%/°C			
Normal Operting Cell Temperature	45±2°C			
Tolerance	0- +5W			



Rosen Solar

To light up the world

Alibaba TOP 3 Suppliers
Trade Assurance Supplier

Verified Alibaba Supplier

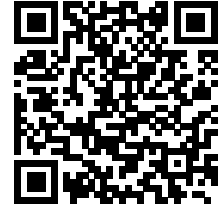

RS72M Black Series

Monocrystalline 72cells
Power Range: 340-380W

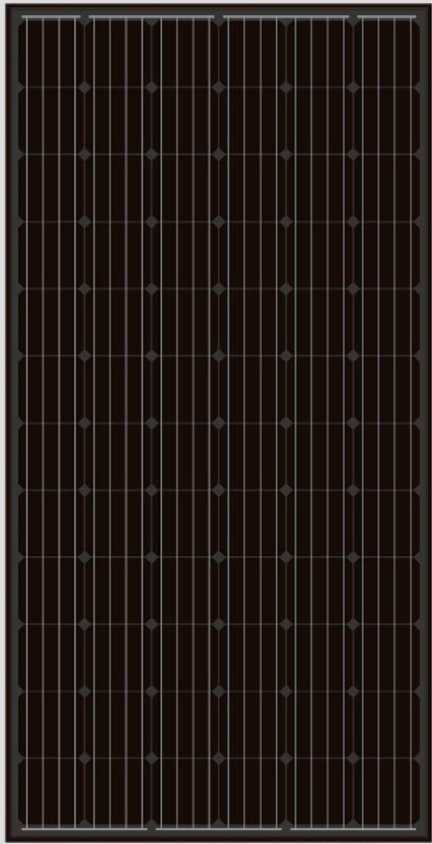

Key Features



Monocrystalline modules designed for commercial and solar farm grid-tied applications



High power output and highest conversion efficiency



Anti-reflective and anti-soiling surface reduces power loss from dirt and dust



Outstanding performance in low-light irradiance environments



Excellent mechanical load resistance: Certified to withstand high wind loads (2400Pa) and snow loads (5400Pa)



High salt and ammonia resistance certified by TÜV NORD

Superior Warranty

- 10-year product warranty
- 25-year linear power output warranty

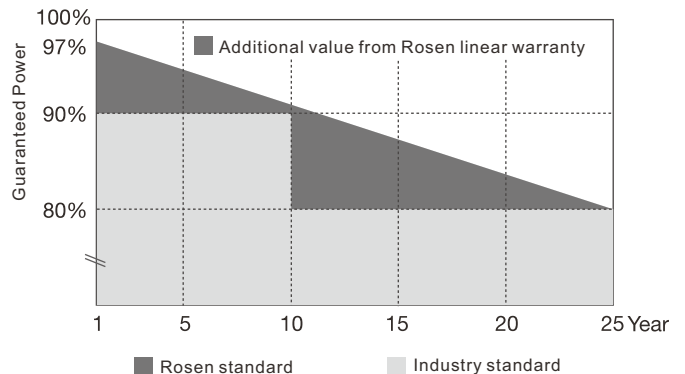

Reliable Quality

- Positive power tolerance: 0~+5W
- 100% EL double-inspection ensures modules are defects free
- Modules binned by current to improve system performance
- Potential Induced Degradation(PID) Resistant



RS72M Black Series

Monocrystalline 72 cells
Power Range: 340-380W

Mechanical Data

Solar Cells	Mono 156*156mm, 5BB
Cell Orientation	72cells (6*12)
Module Dimensions	1956*992*40mm
Weight	22kg (Approx)
Glass	3.2mm, High Transmission, AR Coated Tempered Glass
J-Box	IP67 or IP68 rated
Cables	Photovoltaic Technology Cable 4.0mm ² , 900mm
Connector	MC4/UTX/TS4/QC4*

Working Conditions

Maximum System Voltage	1000 V DC (IEC)
Operational Temperature	-40~ +85°C
Max Series Fuse Rating	20A
NOCT	44°C(±2°C)
Application Class	Class A
Packaging Configuration	Modules per pallet: 27 pieces Modules per 40' container: 720 pieces

Dimensions of PV Module(mm)

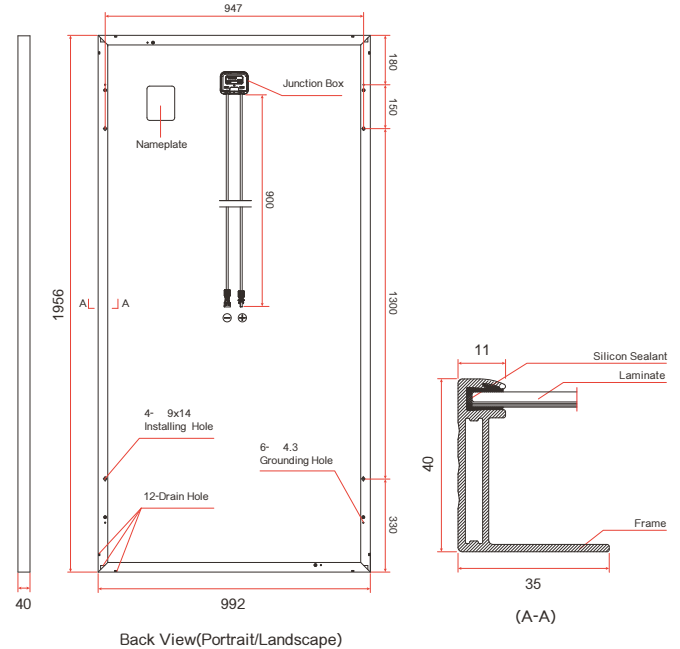

Electrical Data(STC)

Module	RS340M-72	RS345M-72	RS350M-72	RS355M-72	RS360M-72	RS365M-72	RS370M-72	RS375M-72	RS380M-72
Peak Power Watts-Pmax(Wp)*	340	345	350	355	360	365	370	375	380
Maximum Power Voltage-Vmpp(V)	38.2	38.5	38.7	38.9	39.0	39.3	39.7	40.0	40.4
Maximum Power Current-Impp(A)	8.91	8.97	9.05	9.14	9.24	9.30	9.33	9.38	9.41
Open Circuit Voltage-Voc(V)	46.2	46.7	47.0	47.4	47.7	48.0	48.3	48.5	48.8
Short Circuit Current-Isc(A)	9.5	9.55	9.60	9.65	9.70	9.77	9.83	9.88	9.93
Module Efficiency (%)	17.5	17.7	18.0	18.3	18.5	18.8	19.0	19.3	19.5
Power Output Tolerance-Pmax(W)	0 ~+5								
Temperature Coefficient of Pmax	-0.39%/°C								
Temperature Coefficient of Voc	-0.29%/°C								
Temperature Coefficient of Isc	0.05%/°C								

STC Irradiance 1000W/m², Cell Temperature 25°C, Air Mass AM1.5

I-V Curve

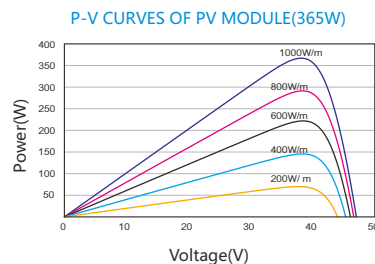
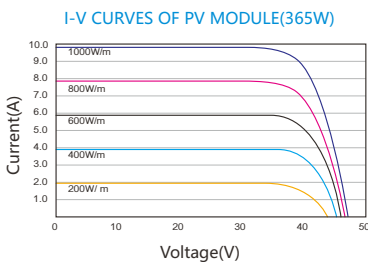

Appearance Color

Back sheet	Black
Frame	Black Anodized Aluminium Alloy



Rosen Solar

To light up the world

Alibaba TOP 3 Suppliers
Trade Assurance Supplier

Verified Alibaba Supplier

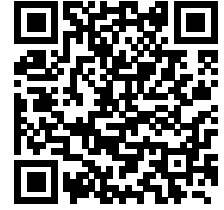

RS72P Black Series

Polycrystalline 72cells

Power Range: 330-360W

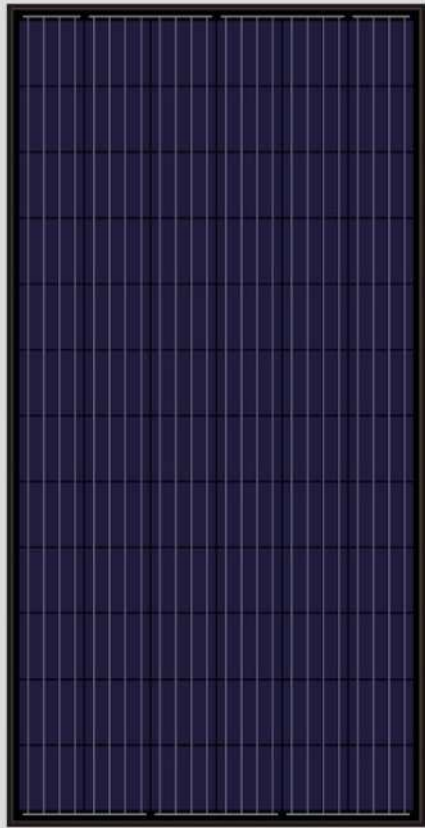

Key Features



Monocrystalline modules designed for commercial and solar farm grid-tied applications



High power output and highest conversion efficiency



Anti-reflective and anti-soiling surface reduces power loss from dirt and dust



Outstanding performance in low-light irradiance environments



Excellent mechanical load resistance: Certified to withstand high wind loads (2400Pa) and snow loads (5400Pa)



High salt and ammonia resistance certified by TÜV NORD

Superior Warranty

- 10-year product warranty
- 25-year linear power output warranty

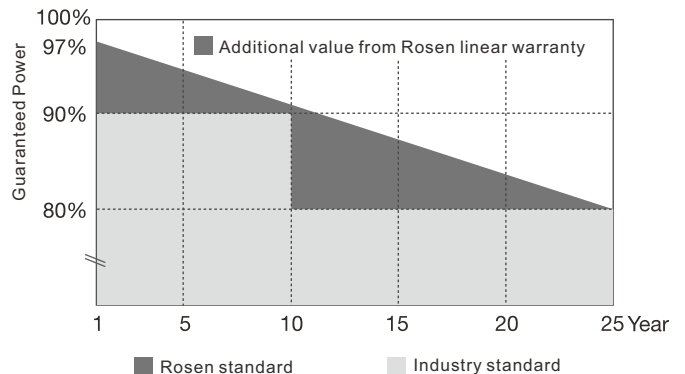

Reliable Quality

- Positive power tolerance: 0~+5W
- 100% EL double-inspection ensures modules are defects free
- Modules binned by current to improve system performance
- Potential Induced Degradation(PID) Resistant



RS72P Black Series

Polycrystalline 72 cells
Power Range: 330-360W

Mechanical Data

Solar Cells	Poly 156*156mm, 5BB
Cell Orientation	72cells (6*12)
Module Dimensions	1956*992*40mm
Weight	22kg (Approx)
Glass	3.2mm, High Transmission, AR Coated Tempered Glass
J-Box	IP67 or IP68 rated
Cables	Photovoltaic Technology Cable 4.0mm ² , 900mm
Connector	MC4/UTX/TS4/QC4*

Working Conditions

Maximum System Voltage	1000 V DC (IEC)
Operational Temperature	-40~ +85°C
Max Series Fuse Rating	15A
NOCT	44°C(±2°C)
Application Class	Class A
Packaging Conginguration	Modules per pallet: 27 pieces Modules per 40' container: 720 pieces

Dimensions of PV Module(mm)

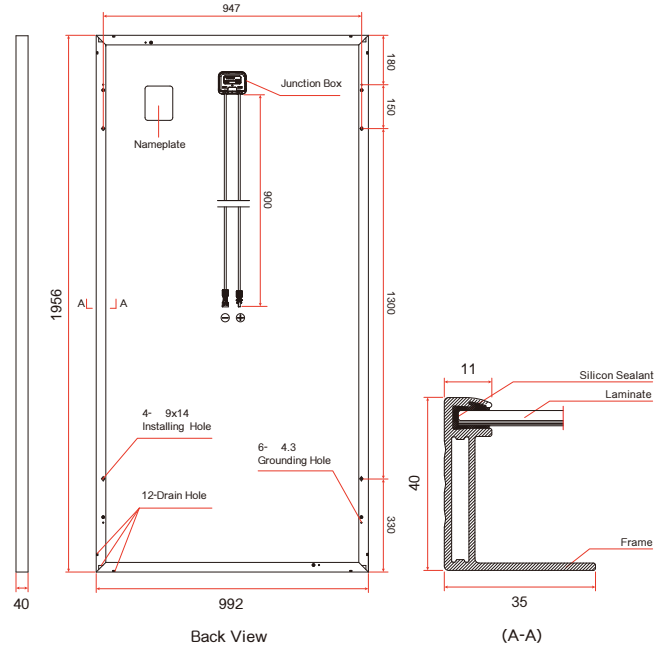

Electrical Data(STC)

Module	RS330P-72	RS335P-72	RS340P-72	RS345P-72	RS350P-72	RS355P-72	RS360P-72
Peak Power Watts-Pmax(Wp)*	330	335	340	345	350	355	360
Maximum Power Voltage-Vmpp(V)	37.4	37.6	37.8	38.1	38.3	38.5	38.7
Maximum Power Current-Impp(A)	8.83	8.91	9.00	9.07	9.16	9.24	9.32
Open Circuit Voltage-Voc(V)	45.8	46.0	46.2	46.4	46.5	46.7	46.9
Short Circuit Current-Isc(A)	9.28	9.35	9.42	9.50	9.57	9.65	9.72
Module Efficiency (%)	17.0	17.2	17.5	17.8	18.0	18.3	18.5
Power Output Tolerance-Pmax(W)	0 ~+5						
Temperature Coefficient of Pmax	-0.41%/°C						
Temperature Coefficient of Voc	-0.32%/°C						
Temperature Coefficient of Isc	0.05%/°C						

STC Irradiance 1000W/m², Cell Temperature 25°C, Air Mass AM1.5

I-V Curve

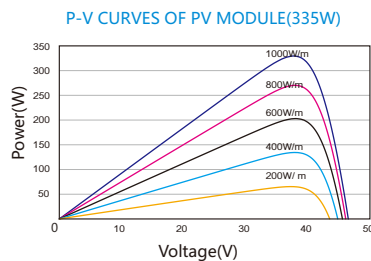
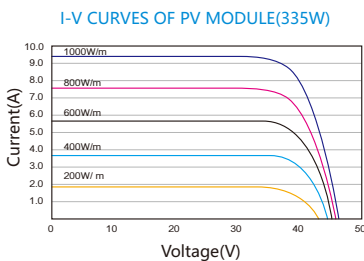

Appearance Color

Back sheet	Black
Frame	Black Anodized Aluminium Alloy



Rosen Solar

To light up the world

Alibaba TOP 3 Suppliers
Trade Assurance Supplier

Verified Alibaba Supplier

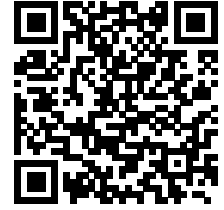

RS60M Black Series

Monocrystalline 60cells
Power Range: 275-315W

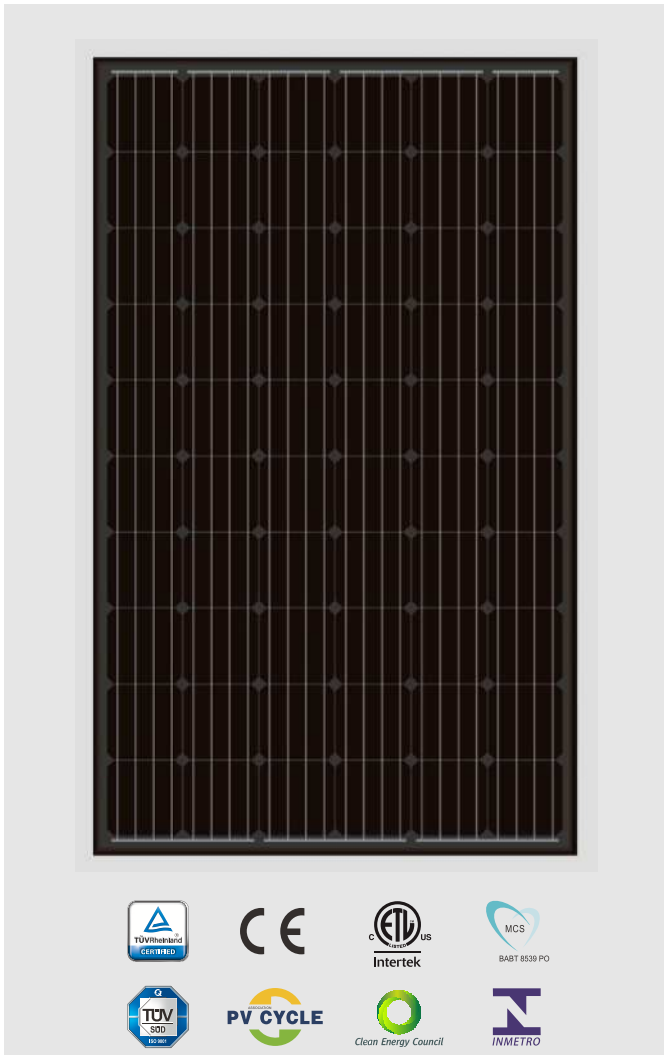

Key Features



Monocrystalline modules designed for commercial and solar farm grid-tied applications



High power output and highest conversion efficiency



Anti-reflective and anti-soiling surface reduces power loss from dirt and dust



Outstanding performance in low-light irradiance environments



Excellent mechanical load resistance: Certified to withstand high wind loads (2400Pa) and snow loads (5400Pa)



High salt and ammonia resistance certified by TÜV NORD

Superior Warranty

- 10-year product warranty
- 25-year linear power output warranty

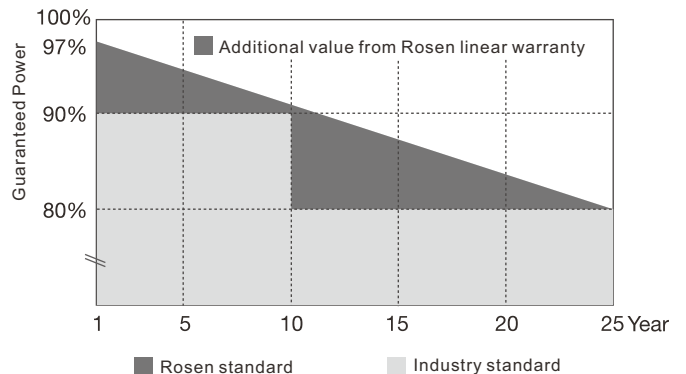

Reliable Quality

- Positive power tolerance: 0~+5W
- 100% EL double-inspection ensures modules are defects free
- Modules binned by current to improve system performance
- Potential Induced Degradation(PID) Resistant



RS60M Black Series

Monocrystalline 60 cells
Power Range: 275-315W

Mechanical Data

Solar Cells	Mono 156*156mm,5BB
Cell Orientation	60cells (6*10)
Module Dimensions	1640*992*35mm
Weight	18kg (Approx)
Glass	3.2mm, High Transmission, AR Coated Tempered Glass
J-Box	IP67 or IP68 rated
Cables	Photovoltaic Technology Cable 4.0mm ² , 900mm
Connector	MC4/UTX/TS4/QC4*

Working Conditions

Maximum System Voltage	1000 V DC (IEC)
Operational Temperature	-40~ +85°C
Max Series Fuse Rating	15A
NOCT	44°C(±2°C)
Application Class	Class A
Packaging Configuration	Modules per pallet: 30 pieces Modules per 40' container: 910 pieces

Dimensions of PV Module(mm)

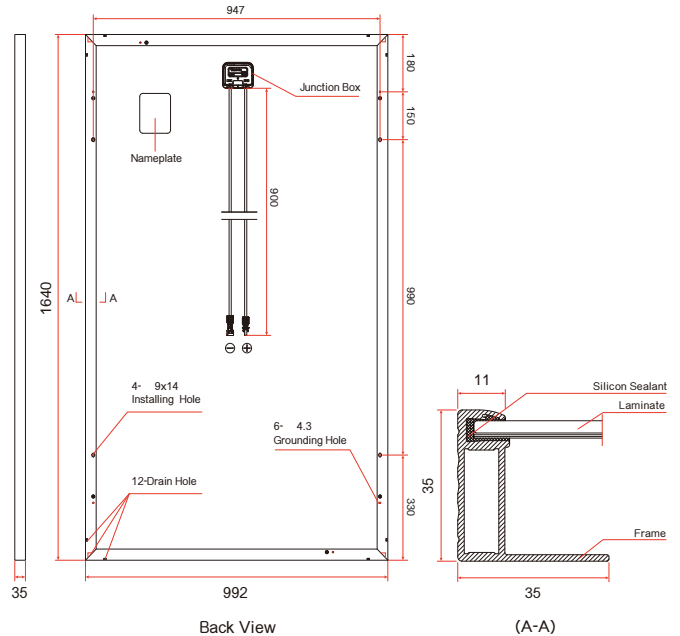

Electrical Data(STC)

Module	RS275M-60	RS280M-60	RS285M-60	RS290M-60	RS295M-60	RS300M-60	RS305M-60	RS310M-60	RS315M-60
Peak Power Watts-Pmax(Wp)*	275	280	285	290	295	300	305	310	315
Maximum Power Voltage-Vmpp(V)	31.4	31.7	31.8	32.2	32.5	32.7	32.9	33.1	33.3
Maximum Power Current-Impp(A)	8.76	8.84	8.97	9.01	9.08	9.19	9.28	9.37	9.46
Open Circuit Voltage-Voc(V)	38.4	38.4	38.5	38.9	39.6	39.8	40.0	40.2	40.5
Short Circuit Current-Isc(A)	9.24	9.42	9.51	9.66	9.68	9.77	9.85	9.94	10.0
Module Efficiency (%)	16.8	17.1	17.4	17.7	18.0	18.3	18.5	18.9	19.2
Power Output Tolerance-Pmax(W)	0 ~+5								
Temperature Coefficient of Pmax	-0.39%/°C								
Temperature Coefficient of Voc	-0.29%/°C								
Temperature Coefficient of Isc	0.05%/°C								
STC	Irradiance 1000W/m ² , Cell Temperature 25°C, Air Mass AM1.5								

I-V Curve

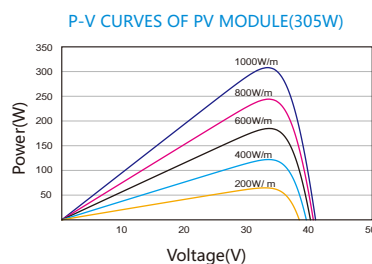
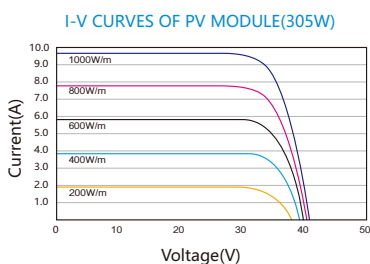

Appearance Color

Back sheet	Black
Frame	Black Anodized Aluminium Alloy



Rosen Solar

To light up the world

Alibaba TOP 3 Suppliers
Trade Assurance Supplier

Verified Alibaba Supplier

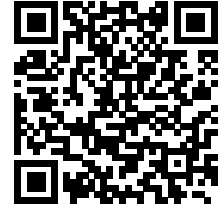

RS60P Black Series

Polycrystalline 60cells
Power Range: 265-285W

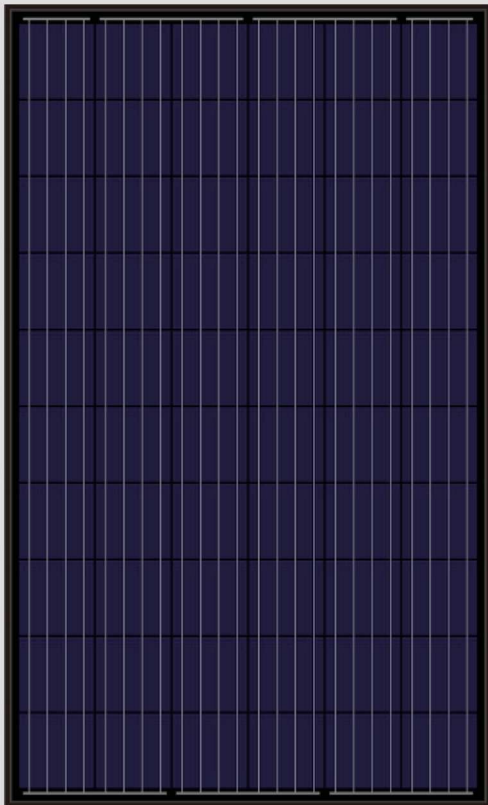

Key Features



Polycrystalline modules designed for commercial and solar farm grid-tied applications



High power output and highest conversion efficiency



Anti-reflective and anti-soiling surface reduces power loss from dirt and dust



Outstanding performance in low-light irradiance environments



Excellent mechanical load resistance: Certified to withstand high wind loads (2400Pa) and snow loads (5400Pa)



High salt and ammonia resistance certified by TÜV NORD

Superior Warranty

- 10-year product warranty
- 25-year linear power output warranty

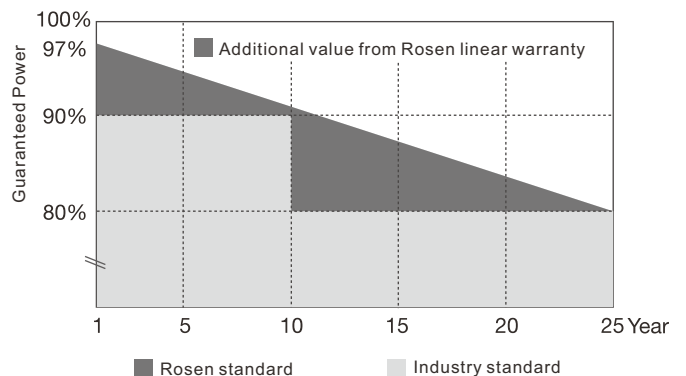

Reliable Quality

- Positive power tolerance: 0~+5W
- 100% EL double-inspection ensures modules are defects free
- Modules binned by current to improve system performance
- Potential Induced Degradation(PID) Resistant



RS60P Black Series

Polycrystalline 60 cells
Power Range: 265-285W

Mechanical Data

Solar Cells	Poly 156*156mm,5BB
Cell Orientation	60cells (6*10)
Module Dimensions	1640*992*35mm
Weight	18kg (Approx)
Glass	3.2mm, High Transmission, AR Coated Tempered Glass
J-Box	IP67 or IP68 rated
Cables	Photovoltaic Technology Cable 4.0mm ² , 900mm
Connector	MC4/UTX/TS4/QC4*

Working Conditions

Maximum System Voltage	1000 V DC (IEC)
Operational Temperature	-40~ +85°C
Max Series Fuse Rating	15A
NOCT	44°C(±2°C)
Application Class	Class A
Packaging Conginguration	Modules per pallet: 30 pieces Modules per 40' container: 910 pieces

Dimensions of PV Module(mm)

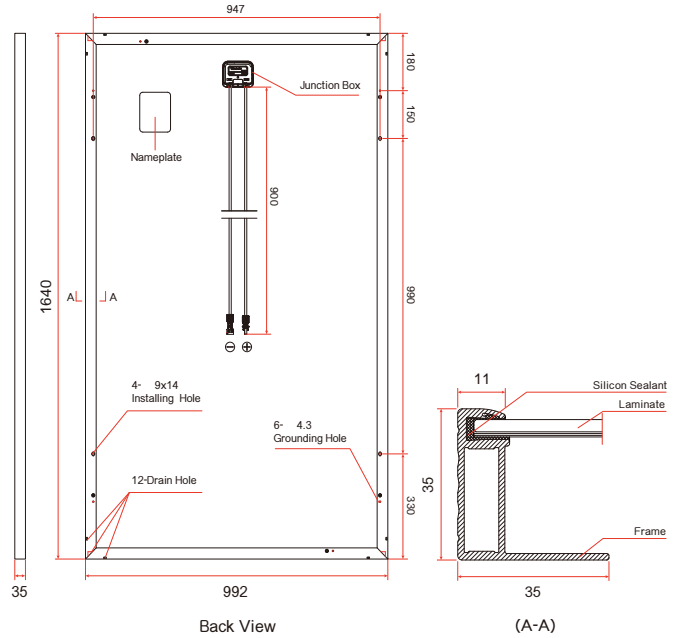

Electrical Data(STC)

Module	RS265P-60	RS270P-60	RS275P-60	RS280P-60	RS285P-60
Peak Power Watts-Pmax(Wp)*	265	270	275	280	285
Maximum Power Voltage-Vmpp(V)	30.8	31.0	31.1	31.4	31.6
Maximum Power Current-Impp(A)	8.61	8.73	8.85	8.92	9.02
Open Circuit Voltage-Voc(V)	37.7	37.9	38.1	38.2	38.3
Short Circuit Current-Isc(A)	9.15	9.22	9.32	9.40	9.49
Module Efficiency (%)	16.2	16.5	16.8	17.1	17.4
Power Output Tolerance-Pmax(W)			0 ~+5		
Temperature Coefficient of Pmax			-0.41%/°C		
Temperature Coefficient of Voc			-0.32%/°C		
Temperature Coefficient of Isc			0.05%/°C		

STC Irradiance 1000W/m², Cell Temperature 25°C, Air Mass AM1.5

I-V Curve

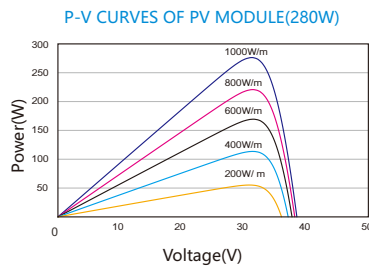
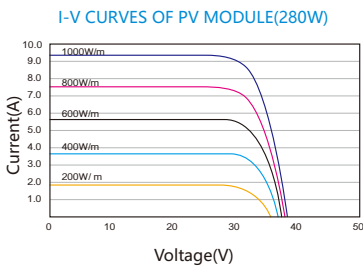

Appearance Color

Back sheet	Black
Frame	Black Anodized Aluminium Alloy



Rosen Solar

To light up the world

Alibaba TOP 3 Suppliers
Trade Assurance Supplier

Verified Alibaba Supplier

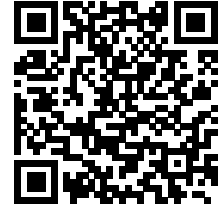

RS36M Black Series

Monocrystalline 36cells
Power Range: 170-190W

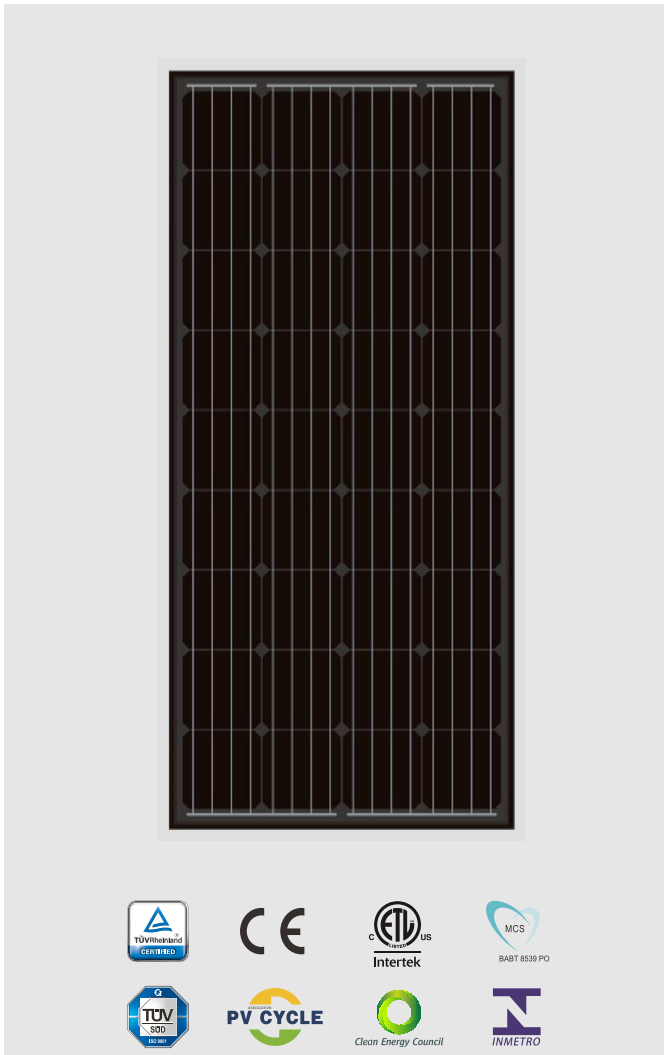

Key Features



Monocrystalline modules designed for commercial and solar farm grid-tied applications



High power output and highest conversion efficiency



Anti-reflective and anti-soiling surface reduces power loss from dirt and dust



Outstanding performance in low-light irradiance environments



Excellent mechanical load resistance: Certified to withstand high wind loads (2400Pa) and snow loads (5400Pa)



High salt and ammonia resistance certified by TÜV NORD

Superior Warranty

- 10-year product warranty
- 25-year linear power output warranty

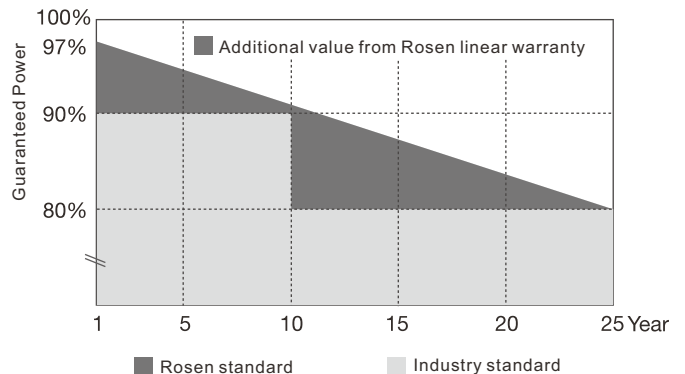

Reliable Quality

- Positive power tolerance: 0~+5W
- 100% EL double-inspection ensures modules are defects free
- Modules binned by current to improve system performance
- Potential Induced Degradation(PID) Resistant



RS36M Black Series

Monocrystalline 36 cells
Power Range: 170-190W

Mechanical Data

Solar Cells	Mono 156*156mm, 5BB
Cell Orientation	36cells (4*9)
Module Dimensions	1480*676*30mm
Weight	10.6kg (Approx)
Glass	3.2mm, High Transmission, AR Coated Tempered Glass
J-Box	IP67 or IP68 rated
Cables	Photovoltaic Technology Cable 4.0mm ² , 900mm
Connector	MC4/UTX/TS4/QC4*

Working Conditions

Maximum System Voltage	1000 V DC (IEC)
Operational Temperature	-40~ +85°C
Max Series Fuse Rating	15A
NOCT	44°C(±2°C)
Application Class	Class A
Packaging Configuration	Modules per pallet: 35pcs Modules per 40' container: 1600pcs

Dimensions of PV Module(mm)

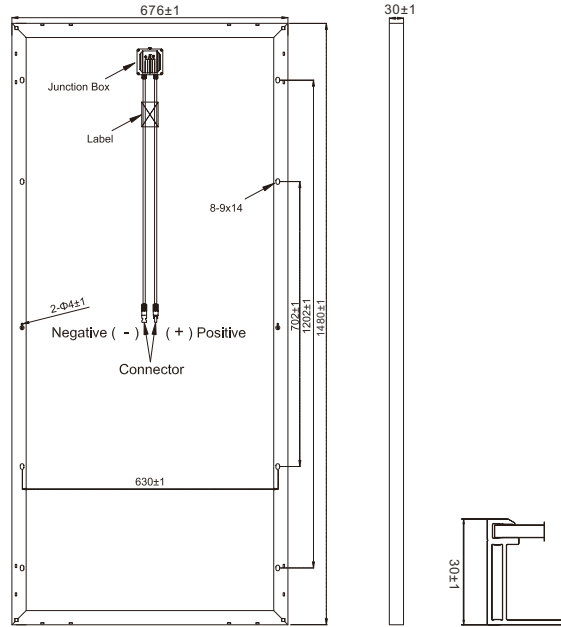

Electrical Data(STC)

Module	RS170M-36	RS175M-36	RS180M-36	RS185M-36	RS190M-36
Peak Power Watts-Pmax(Wp)*	170	175	180	185	190
Maximum Power Voltage-Vmpp(V)	17.9	18.0	18.1	18.2	18.3
Maximum Power Current-Impp(A)	9.50	9.73	9.95	10.17	10.39
Open Circuit Voltage-Voc(V)	22.8	22.9	23.0	23.1	23.2
Short Circuit Current-Isc(A)	9.74	9.98	9.94	10.46	10.70
Module Efficiency (%)	17.08	17.58	18.09	18.59	19.9
Power Output Tolerance-Pmax(W)			0 ~+5		
Temperature Coefficient of Pmax			-0.41%/°C		
Temperature Coefficient of Voc			-0.33%/°C		
Temperature Coefficient of Isc			0.059%/°C		

STC Irradiance 1000W/m², Cell Temperature 25°C, Air Mass AM1.5

I-V Curve

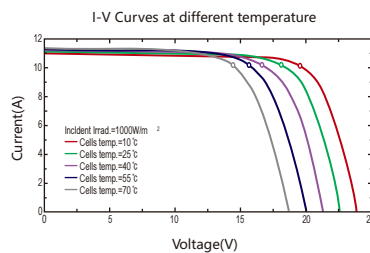
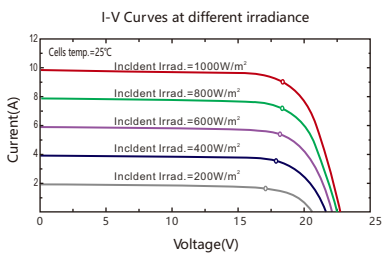

Appearance Color

Back sheet	Black
Frame	Black Anodized Aluminium Alloy



Rosen Solar

To light up the world

Alibaba TOP 3 Suppliers
Trade Assurance Supplier

Verified Alibaba Supplier

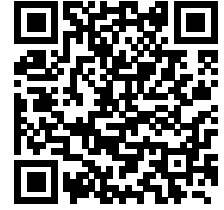

RS36P Black Series

Polycrystalline 36cells

Power Range: 155-175W

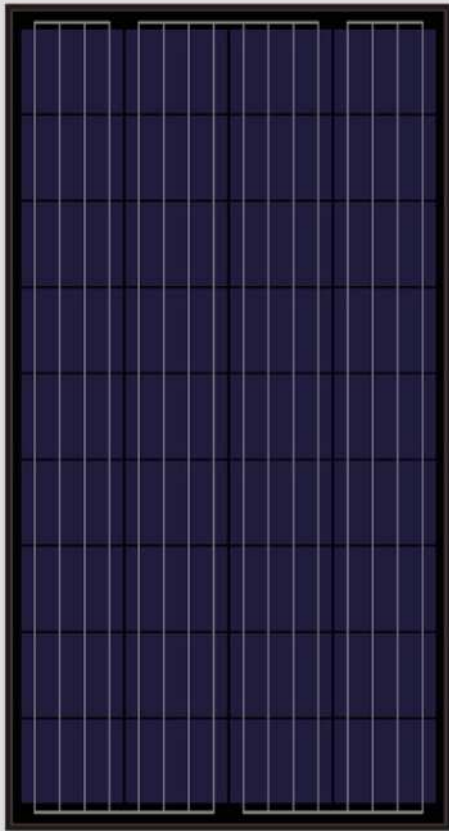

Key Features



Monocrystalline modules designed for commercial and solar farm grid-tied applications



High power output and highest conversion efficiency



Anti-reflective and anti-soiling surface reduces power loss from dirt and dust



Outstanding performance in low-light irradiance environments



Excellent mechanical load resistance: Certified to withstand high wind loads (2400Pa) and snow loads (5400Pa)



High salt and ammonia resistance certified by TÜV NORD

Superior Warranty

- 10-year product warranty
- 25-year linear power output warranty

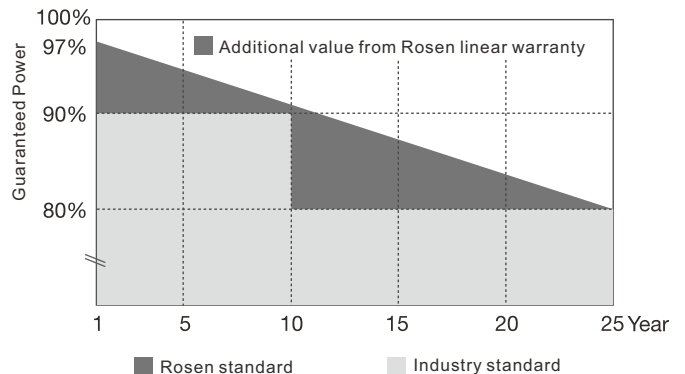

Reliable Quality

- Positive power tolerance: 0~+5W
- 100% EL double-inspection ensures modules are defects free
- Modules binned by current to improve system performance
- Potential Induced Degradation(PID) Resistant



RS36P Black Series

Polycrystalline 36 cells
Power Range: 155-175W

Mechanical Data

Solar Cells	Poly 156*156mm, 5BB
Cell Orientation	36cells (4*9)
Module Dimensions	1480*676*30mm
Weight	10.6kg (Approx)
Glass	3.2mm, High Transmission, AR Coated Tempered Glass
J-Box	IP67 or IP68 rated
Cables	Photovoltaic Technology Cable 4.0mm ² , 900mm
Connector	MC4/UTX/TS4/QC4*

Working Conditions

Maximum System Voltage	1000 V DC (IEC)
Operational Temperature	-40~ +85°C
Max Series Fuse Rating	15A
NOCT	44°C(±2°C)
Application Class	Class A
Packaging Configuration	Modules per pallet: 35pcs Modules per 40' container: 1600pcs

Dimensions of PV Module(mm)

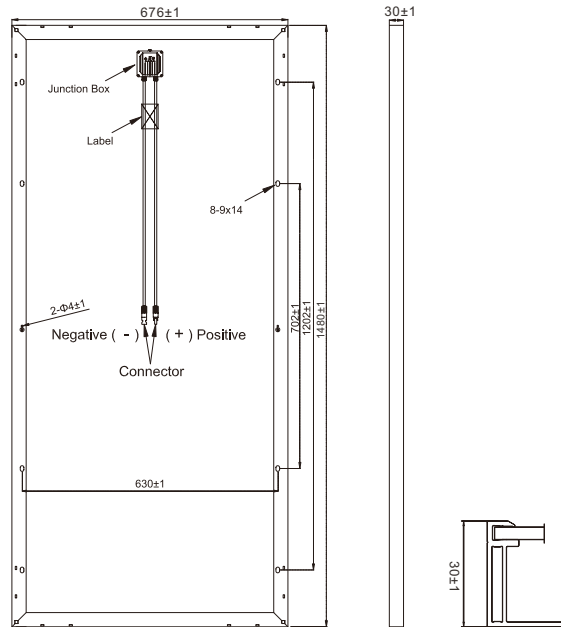

Electrical Data(STC)

Module	RS155P-36	RS160P-36	RS165P-36	RS170P-36	RS175P-36
Peak Power Watts-Pmax(Wp)*	155	160	165	170	175
Maximum Power Voltage-Vmpp(V)	17.6	17.7	17.8	17.9	18.00
Maximum Power Current-Impp(A)	8.81	9.04	9.27	9.50	9.73
Open Circuit Voltage-Voc(V)	22.5	22.6	22.7	22.8	22.9
Short Circuit Current-Isc(A)	9.05	9.25	9.55	9.74	9.98
Module Efficiency (%)	15.57	16.08	16.58	17.09	17.58
Power Output Tolerance-Pmax(W)			0 ~+5		
Temperature Coefficient of Pmax			-0.41%/°C		
Temperature Coefficient of Voc			-0.33%/°C		
Temperature Coefficient of Isc			0.059%/°C		

STC Irradiance 1000W/m², Cell Temperature 25°C, Air Mass AM1.5

I-V Curve

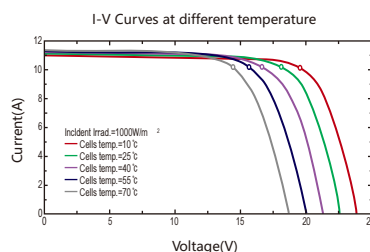
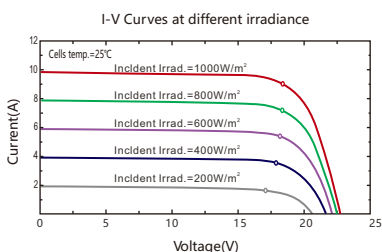

Appearance Color

Back sheet	Black
Frame	Black Anodized Aluminium Alloy