

For a Free Quote:

Web: EnergyPal.com/solar

Call: 1-800-990-3725

Email: contact@energypal.com

EnergyPal

Solar Panel Guide Specification Data Sheet

Wuxi Sunket New Energy Technology Co., Ltd.

SKT140-155P-12

SKT145P-12

Also available on the web at

EnergyPal.com/wuxi-sunket-new-energy-technology-co-ltd-solar-panels/skt145p-12

120~155 Watt

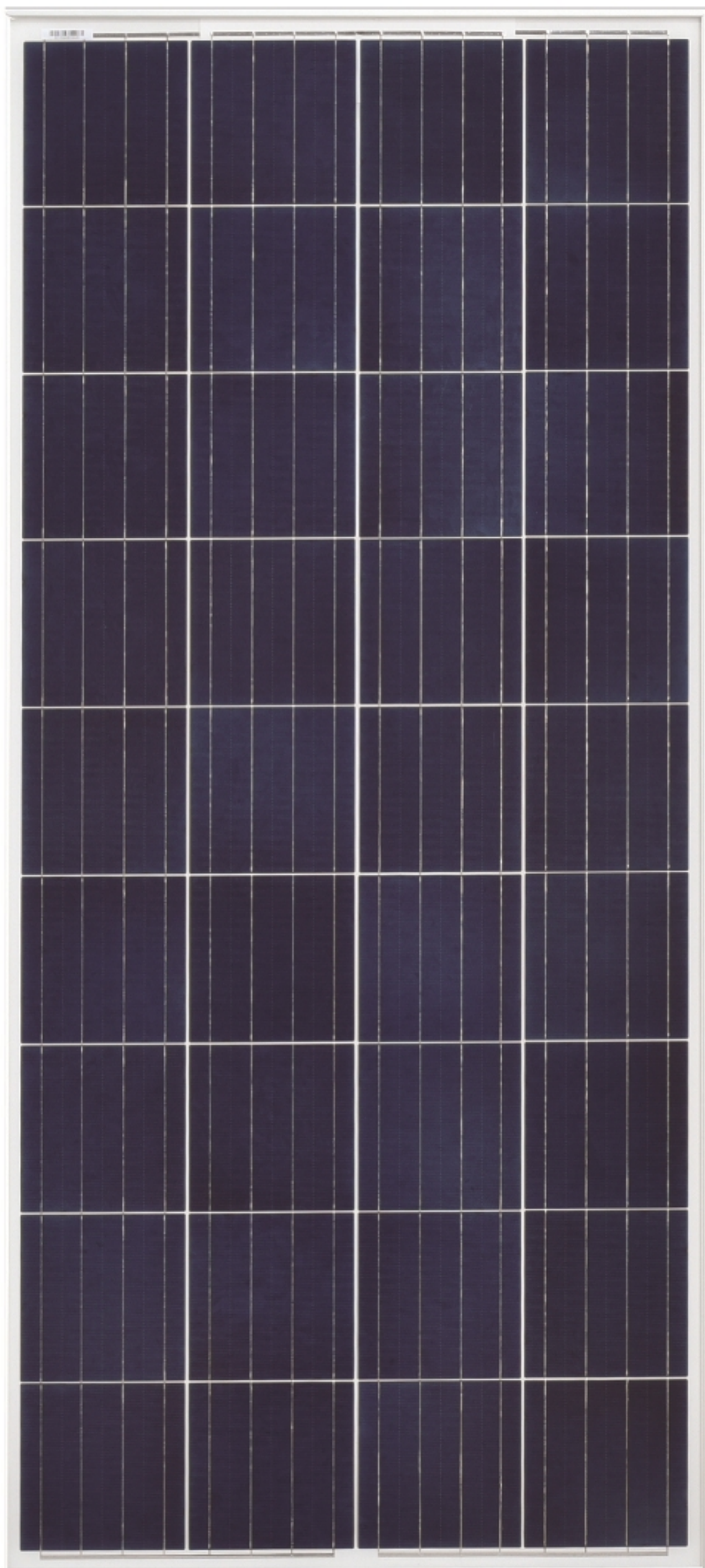

140W~155W

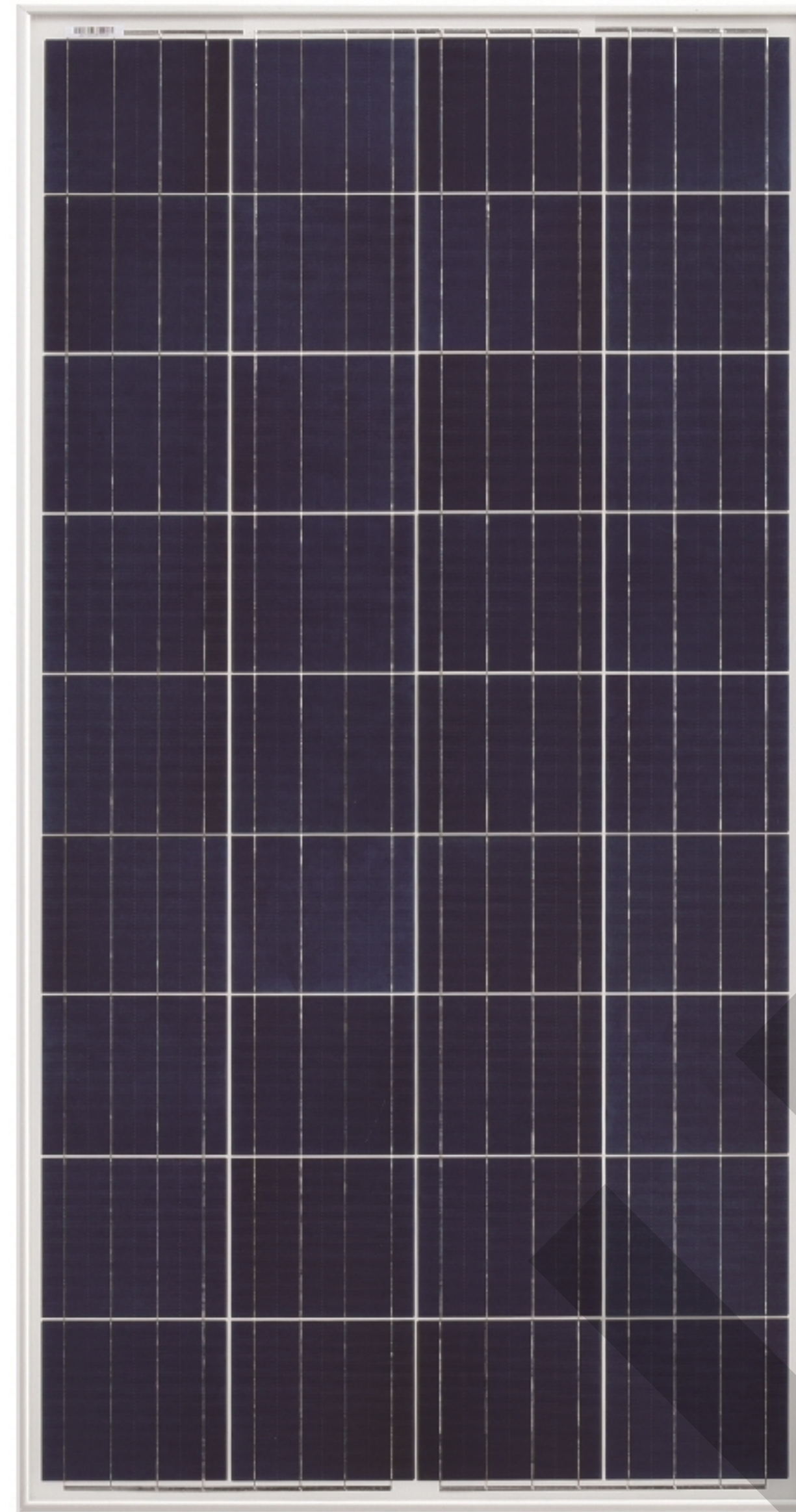

120W~135W



*BLACK FRAME/BLACK BACK-SHEET PRODUCTS ARE AVAILABLE UPON REQUEST

MANAGEMENT SYSTEM



ISO 9001: Quality management system



ISO 14001: Standard for environmental management system



OHSAS 18001: International standard for occupational health and safety assessment system

PRODUCT CERTIFICATES



IEC 61215
IEC 61730
Periodical Inspection



WARRANTY

10 Years
Material & Craft
Quality
assurance

10 Years
90% Output
Power
guarantee

25 Years
80% Output
Power
guarantee

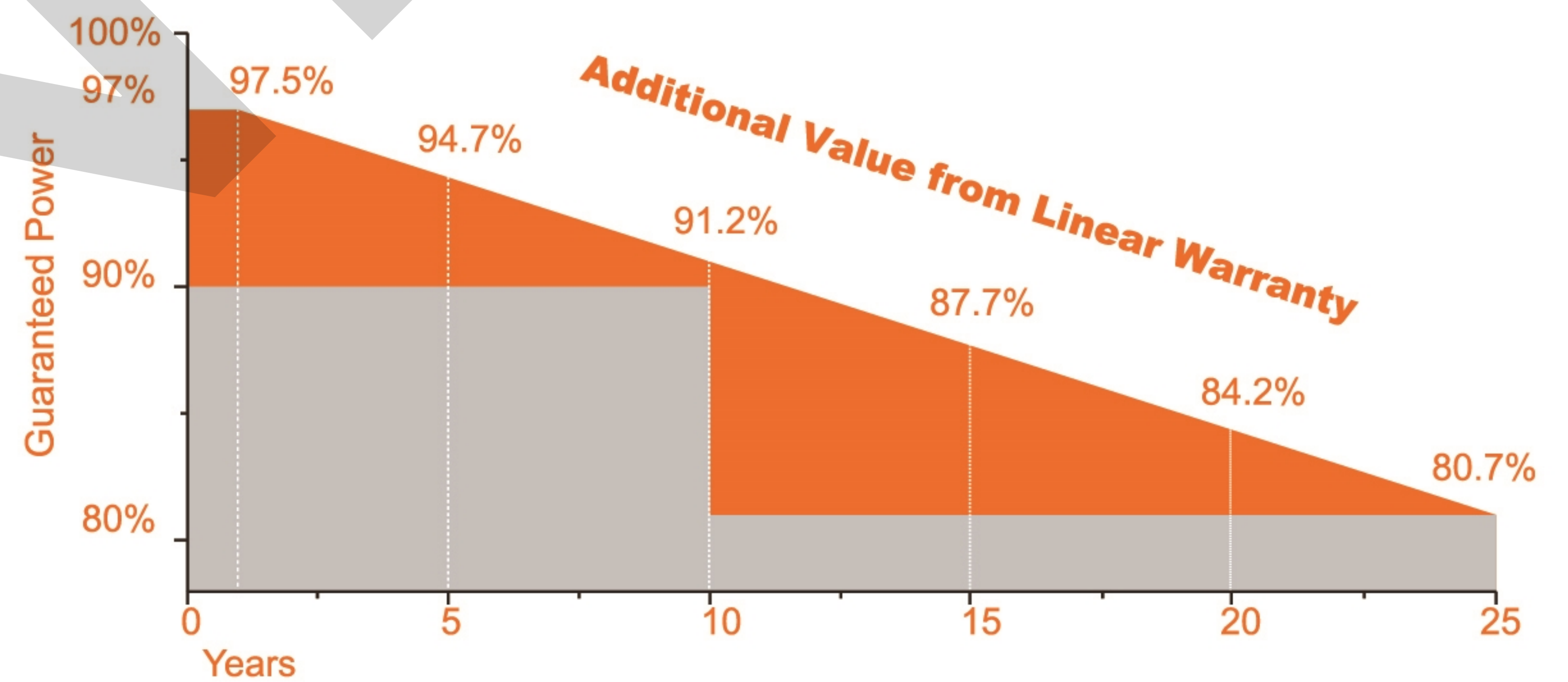

Safety



Safety for salt mist corrosion
(IEC61701, tested in TUV)

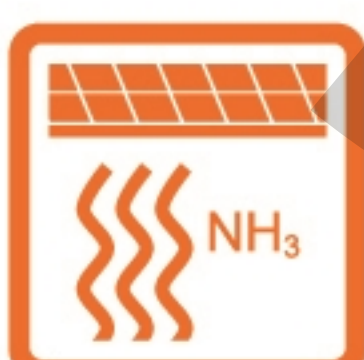

Safety for ammonia corrosion
(IEC62716, tested in TUV)



Safety for fire risk
(Class A, tested in TUV)

Key



High stability of the aluminium
frame



High quality junction box and
connector systems



100% inspection, to guarantee
the reliability of solar systems

Technology



Using high efficiency poly
solar cells



Excellent performance in
low-light environments



High transmissivity, low-iron
tempered glass.

Electrical Characteristics (STC)

Module Type	SKT120P-12	SKT125P-12	SKT130P-12	SKT135P-12
Maximum Power- Pmax(W)	120	125	130	135
Open Circuit Voltage - Voc(V)	22.2	22.2	22.4	22.6
Short- Circuit Current - Isc(A)	7.12	7.42	7.63	7.84
Voltage at Pmax -Vmp(V)	18.2	18.2	18.4	18.6
Current at Pmax - Imp(A)	6.59	6.87	7.07	7.26
Module Efficiency -ηm (%)	14.02	14.60	15.19	15.77

Module Type	SKT140P-12	SKT145P-12	SKT150P-12	SKT155P-12
Maximum Power- Pmax(W)	140	145	150	155
Open Circuit Voltage - Voc(V)	22.2	22.3	22.4	22.5
Short- Circuit Current - Isc(A)	8.31	8.56	8.80	9.05
Voltage at Pmax -Vmp(V)	18.2	18.3	18.4	18.5
Current at Pmax - Imp(A)	7.69	7.92	8.15	8.38
Module Efficiency -ηm (%)	14.09	14.60	15.10	15.60

STC: Irradiance 1000W/m², Cell Temperature 25 °C, Air Mass 1.5

Power Tolerance(W)	(0,+4.99)
Maximum System Voltage(V)	715
Maximum Series Fuse Rating (A)	20
Operating Temperature	-40 ~ +85 °C

Temperature Characteristics

Pmax Temperature Coefficient	-0.40%/°C
Voc Temperature Coefficient	-0.32%/°C
Isc Temperature Coefficient	+0.05%/°C
Operating Temperature	-40 ~ +85 °C
Nominal Operating Cell Temperature(NOCT)	45±2 °C

Mechanical Specifications

Module Type	SKT140P~155P-12	SKT120P~135P-12
External Dimensions	1474×674×35mm	1270×674×35 mm
Weight	11kg	9.5 kg
Poly Solar Cells	156×156mm (36pcs)	133.25×156mm (36pcs)
Front Glass	3.2 mm tempered glass, low iron	3.2 mm tempered glass, low iron
Frame	Anodized aluminum alloy	Anodized aluminum alloy
Junction Box	IP67	IP67
Mechanical Load	5400 Pa	5400 Pa

Packing Configuration

Module Type	SKT140P~155P-12	SKT120P~135P-12
Carton Dimensions	1515×1110×689mm	1310×1110×689mm
Pallet Dimensions	1525×1120×830mm	1320×1120×830mm
Pallet Weight	380kg	335kg
Pieces per Pallet	30(5pcs/carton)	30(5pcs/carton)

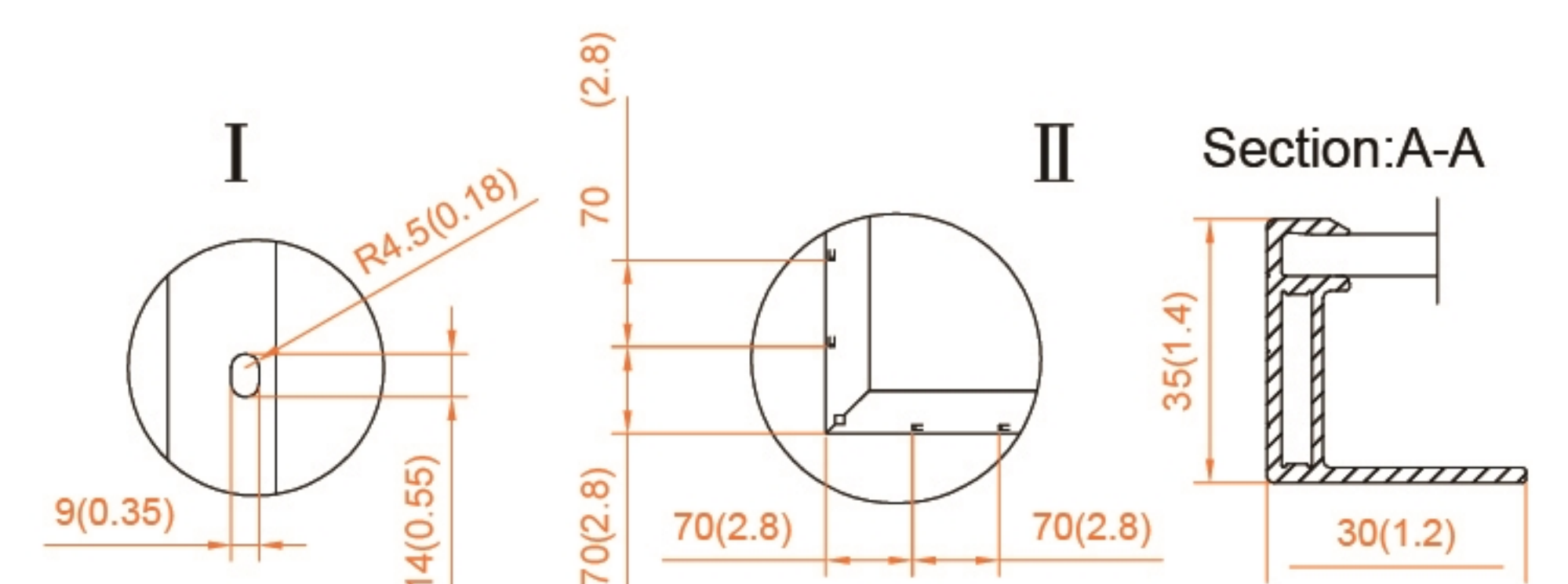
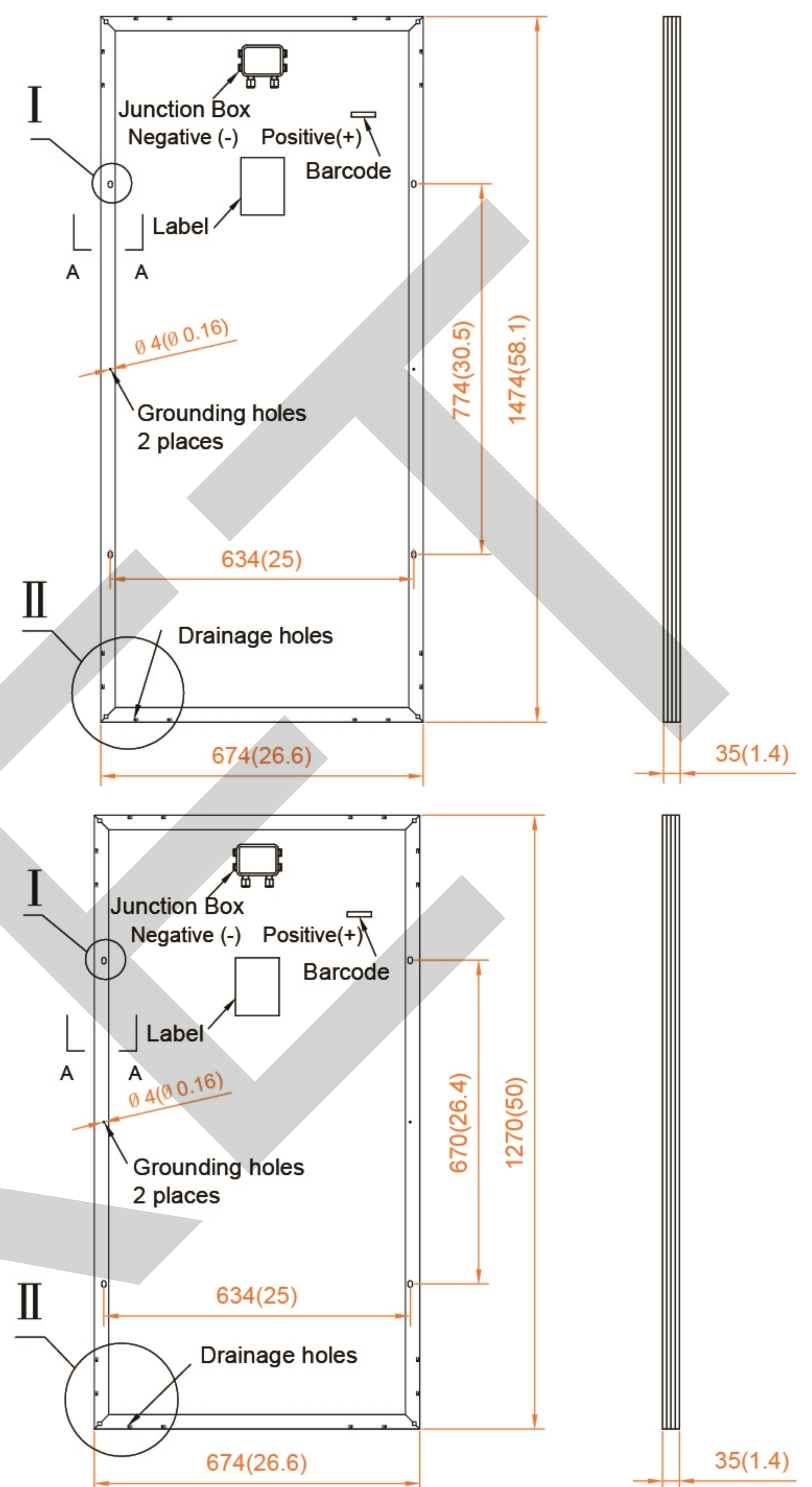

All Dimensions in mm(inch)

The above drawing is a graphical representation of the product.

For engineering quality drawings please contact SUNKET.

I-V Curve (SKT155P-12)

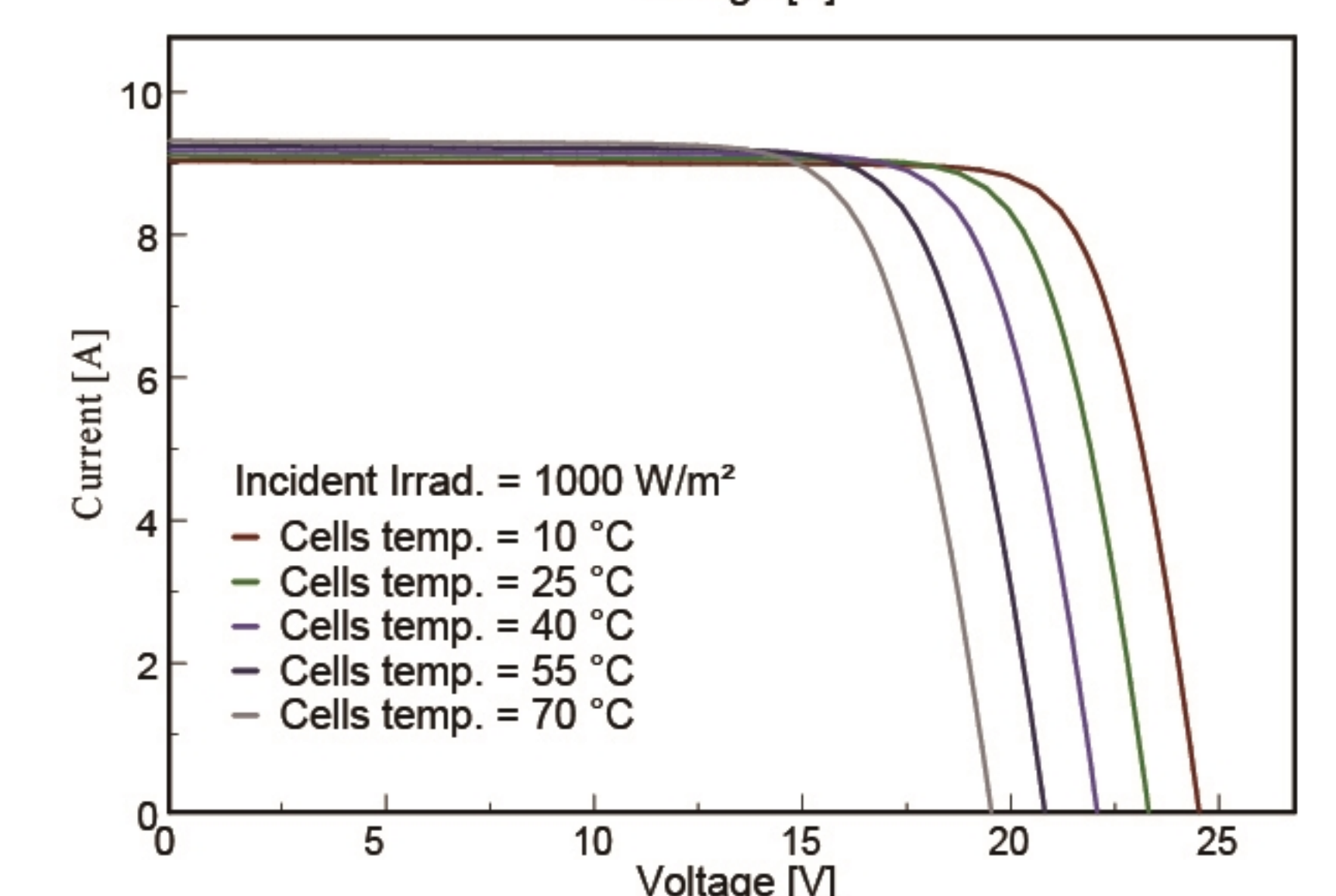
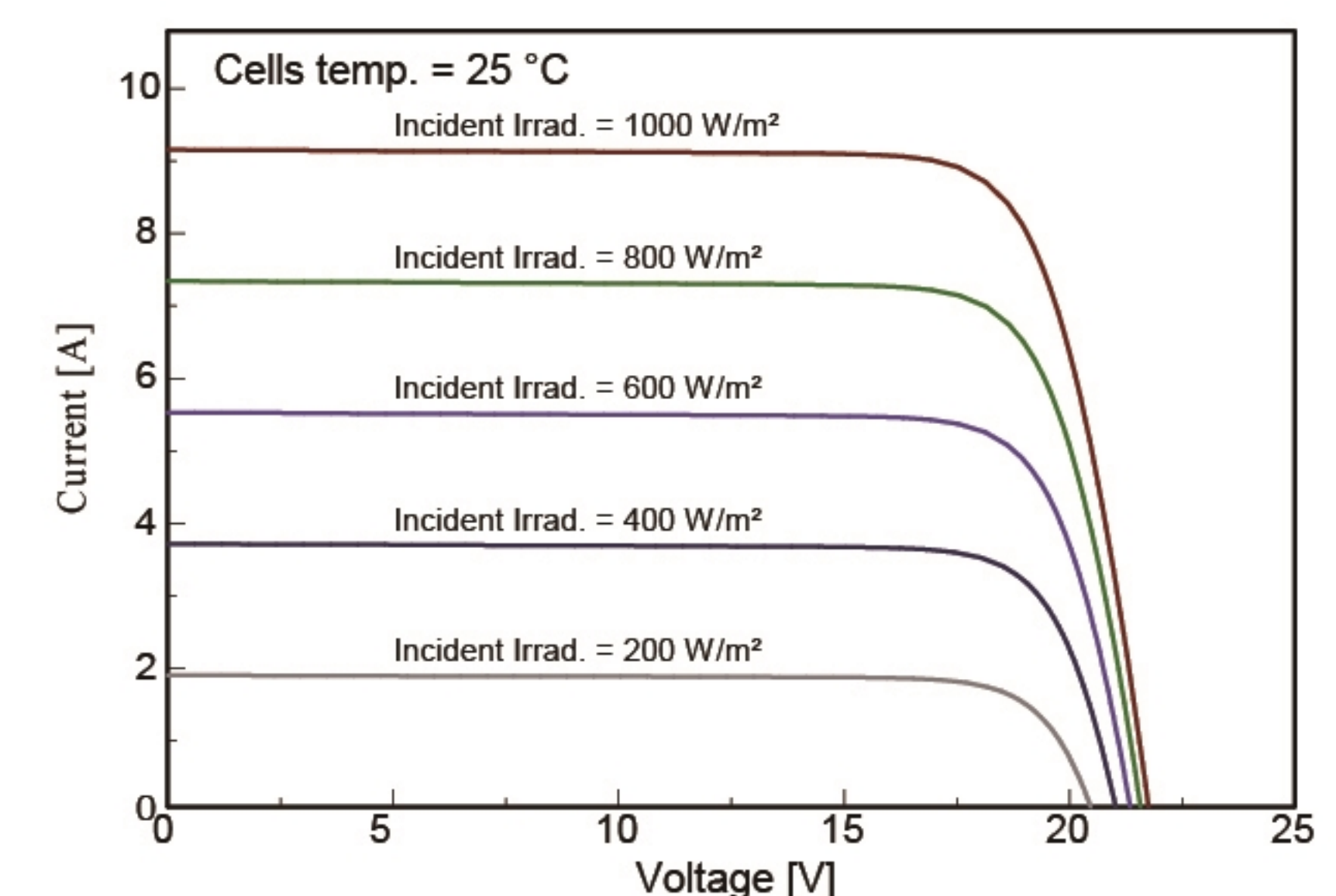

Specifications are subject to change without further notification SKT-EN-2017V1.0 © Copyright 2017 Sunket