

For a Free Quote:

Web: EnergyPal.com/solar

Call: 1-800-990-3725

Email: contact@energypal.com

EnergyPal

Solar Panel Guide Specification Data Sheet

Wuxi Sunket New Energy Technology Co., Ltd.

SKT215-240P-24

SKT225P-24

Also available on the web at

EnergyPal.com/wuxi-sunket-new-energy-technology-co-ltd-solar-panels/skt225p-24

160~240 Watt

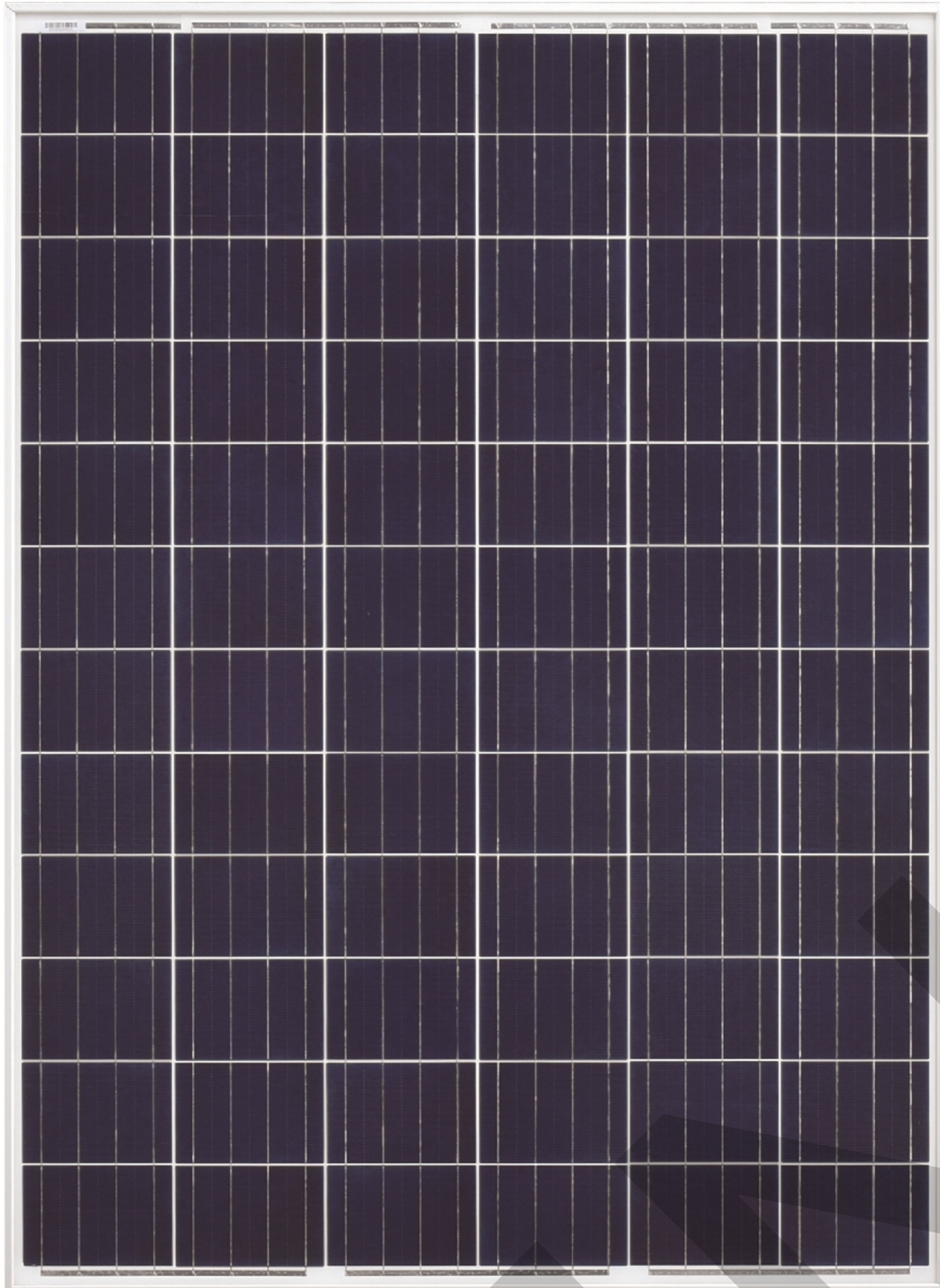

*BLACK FRAME/BLACK BACK-SHEET PRODUCTS ARE AVAILABLE UPON REQUEST

MANAGEMENT SYSTEM

- ISO 9001: Quality management system
- ISO 14001: Standard for environmental management system
- OHSAS 18001: International standard for occupational health and safety assessment system

PRODUCT CERTIFICATES



WARRANTY

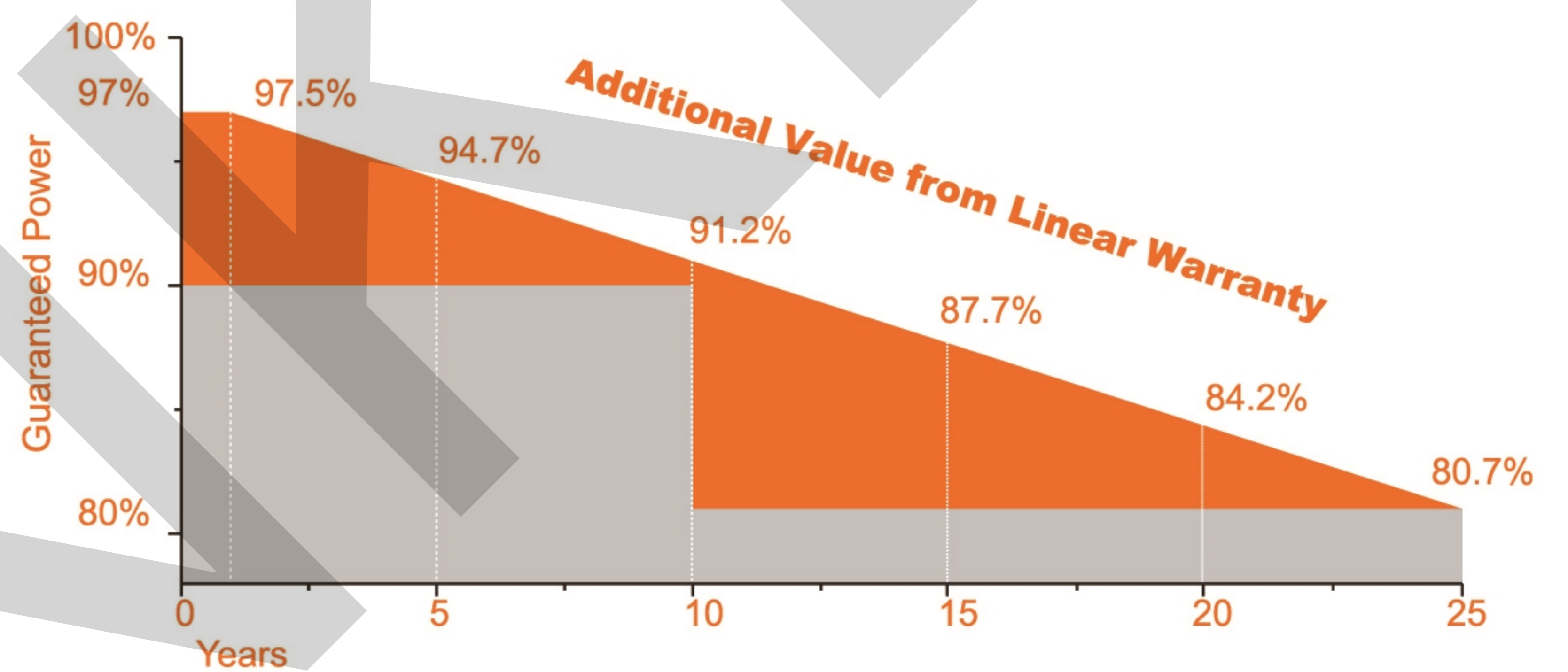

10 Years
 Material & Craft
 Quality
 assurance

10 Years
 90% Output
 Power
 guarantee

25 Years
 80% Output
 Power
 guarantee

Safety

Safety for salt mist corrosion (IEC61701, tested in TUV)

Safety for ammonia corrosion (IEC62716, tested in TUV)

Safety for fire risk (Class A, tested in TUV)

Key

High stability of the aluminium frame

High quality junction box and connector systems

100% inspection, to guarantee the reliability of solar systems

Technology

Using high efficiency poly solar cells

Excellent performance in low-light environments

High transmissivity, low-iron tempered glass.

Electrical Characteristics (STC)

Module Type	SKT160P-24	SKT165P-24	SKT170P-24	SKT175P-24	SKT180P-24	SKT185P-24
Maximum Power- Pmax(W)	160	165	170	175	180	185
Open Circuit Voltage - Voc(V)	44.4	44.6	44.8	45.0	45.2	44.4
Short- Circuit Current - Isc(A)	4.75	4.87	4.99	5.11	5.23	5.49
Voltage at Pmax -Vmp(V)	36.4	36.6	36.8	37.0	37.2	36.4
Current at Pmax - Imp(A)	4.40	4.51	4.62	4.73	4.84	5.08
Module Efficiency -ηm (%)	13.90	14.34	14.77	15.21	15.64	14.02

Module Type	SKT190P-24	SKT195P-24	SKT200P-24	SKT205P-24	SKT210P-24	SKT215P-24
Maximum Power- Pmax(W)	190	195	200	205	210	215
Open Circuit Voltage - Voc(V)	44.6	44.8	44.9	45.1	45.3	44.6
Short- Circuit Current - Isc(A)	5.61	5.72	5.85	5.97	6.08	6.34
Voltage at Pmax -Vmp(V)	36.6	36.8	36.9	37.1	37.3	36.6
Current at Pmax - Imp(A)	5.19	5.30	5.42	5.53	5.63	5.87
Module Efficiency -ηm (%)	14.40	14.78	15.16	15.54	15.92	14.64

Module Type	SKT220P-24	SKT225P-24	SKT230P-24	SKT235P-24	SKT240P-24
Maximum Power- Pmax(W)	220	225	230	235	240
Open Circuit Voltage - Voc(V)	44.8	44.9	45.1	45.3	45.5
Short- Circuit Current - Isc(A)	6.46	6.59	6.70	6.80	6.91
Voltage at Pmax -Vmp(V)	36.8	36.9	37.1	37.3	37.5
Current at Pmax - Imp(A)	5.98	6.10	6.20	6.30	6.40
Module Efficiency -ηm (%)	14.98	15.33	15.67	16.01	16.35

STC: Irradiance 1000W/m², Cell Temperature 25 °C, Air Mass 1.5

Power Tolerance(W)	(0,+4.99)
Maximum System Voltage(V)	1000
Maximum Series Fuse Rating (A)	20
Operating Temperature	-40~+85 °C

Mechanical Specifications

Module Type	SKT215P~240P-24	SKT185P~210P-24	SKT160P~180P-24
External Dimensions	1480×992×35mm	1330×992×35 mm	1160×992×35 mm
Weight	17 kg	15 kg	13 kg
Poly Solar Cells	117×156mm (72pcs)	104×156mm (72pcs)	90×156mm(72pcs)
Front Glass	3.2 mm tempered, low iron	3.2 mm tempered, low iron	3.2 mm tempered, low iron
Frame	Anodized aluminum alloy	Anodized aluminum alloy	Anodized aluminum alloy
Junction Box	IP67	IP67	IP67
Output Cables	4.0 mm ² , cable length: 1000 mm	4.0 mm ² , cable length: 1000 mm	4.0 mm ² , cable length: 1000 mm
Connector	MC4 Compatible	MC4 Compatible	MC4 Compatible
Mechanical Load	5400 Pa	5400 Pa	5400 Pa

Packing Configuration

Module Type	SKT215P~240P-24	SKT185P~210P-24	SKT160P~180P-24
Carton Dimensions	1520×1110×1007mm	1370×1110×1007mm	1200×1110×1007mm
Pallet Dimensions	1530×1120×1140mm	1380×1120×1140mm	1210×1120×1140mm
Pallet Weight	570kg	510kg	450kg
Pieces per Pallet	30(5pcs/carton)	30(5pcs/carton)	30(5pcs/carton)

I-V Curve (SKT240P-24)

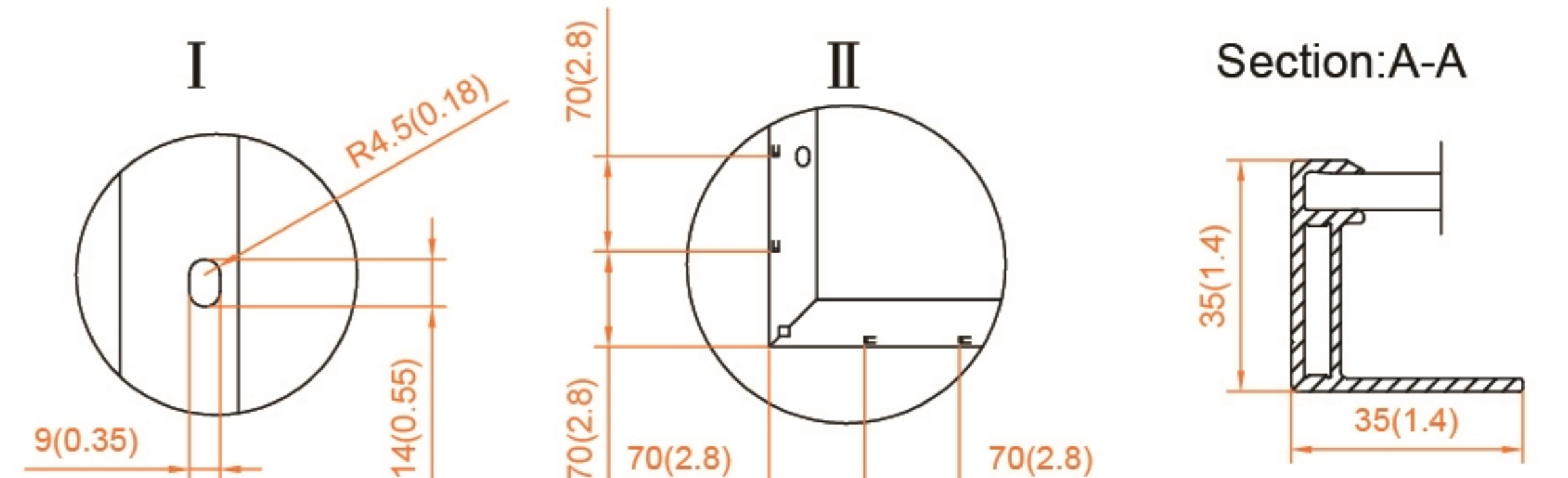
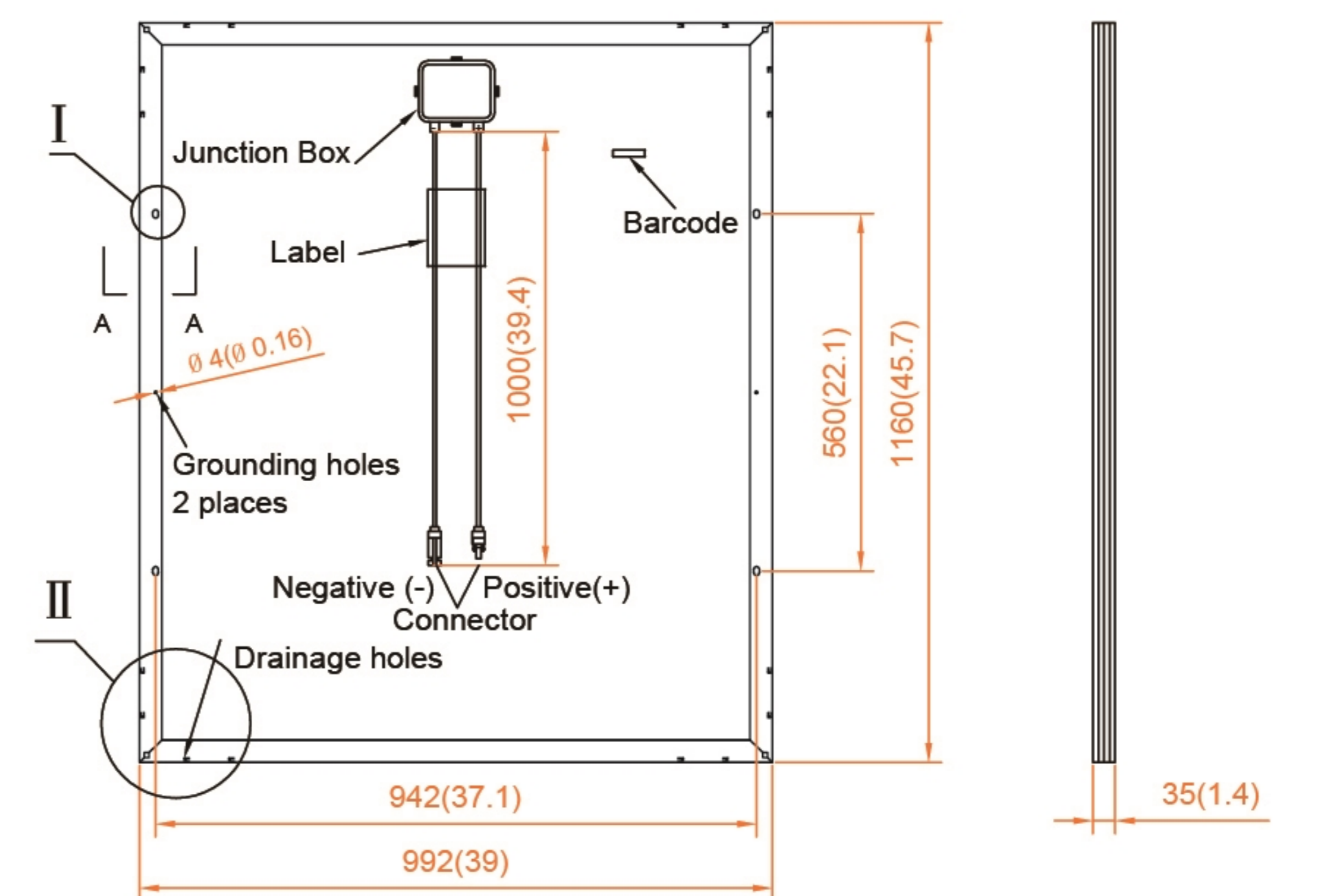
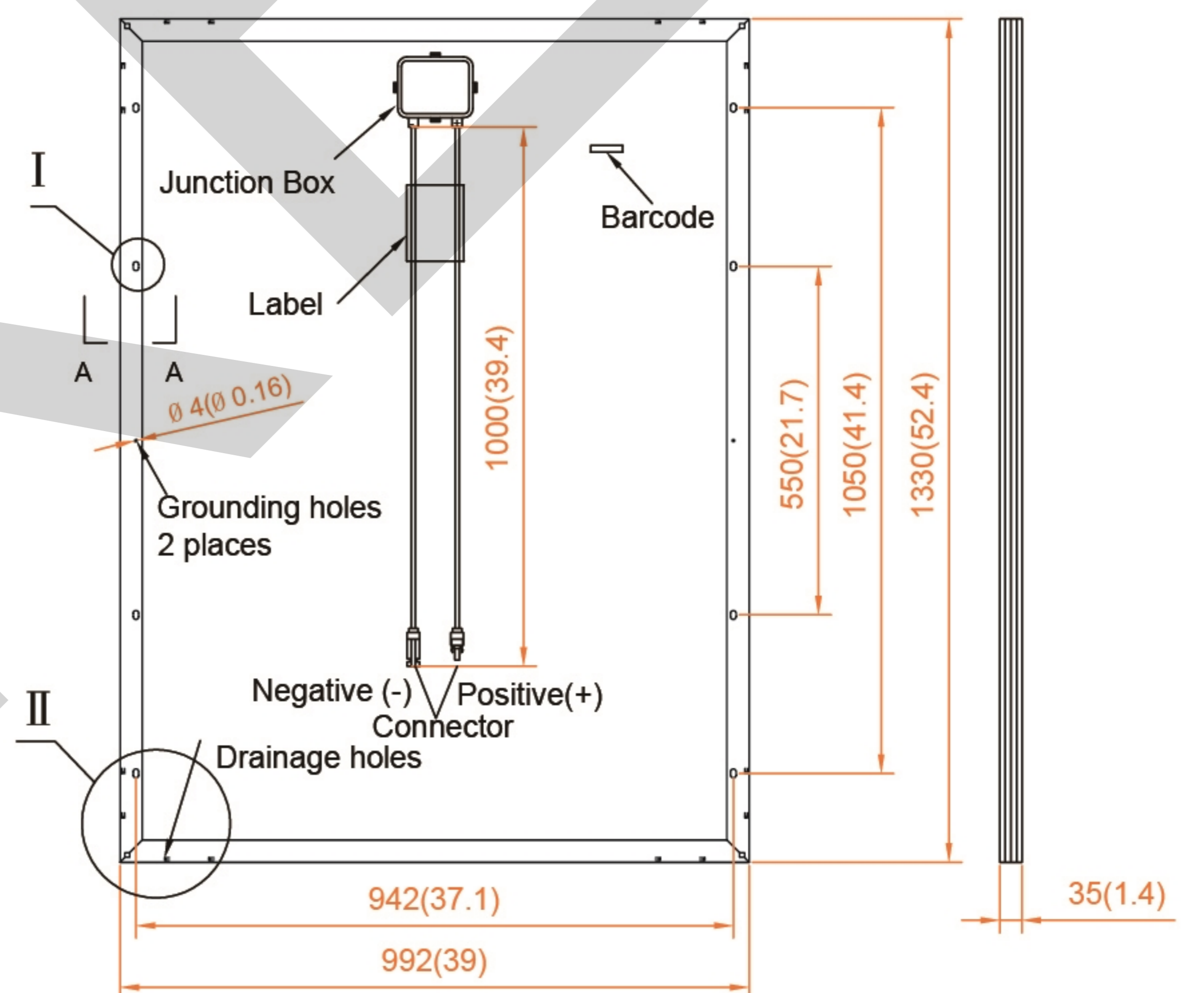
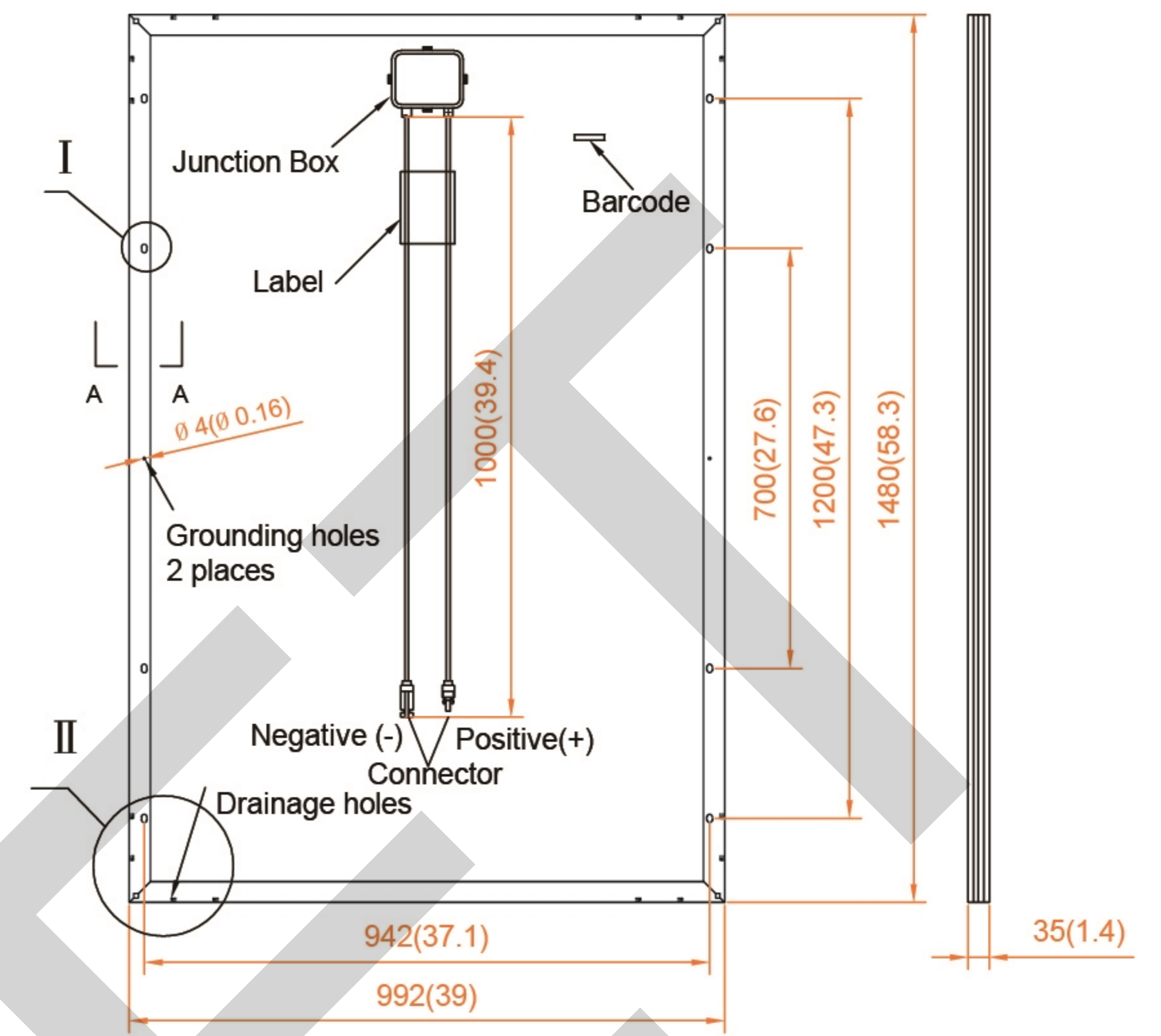
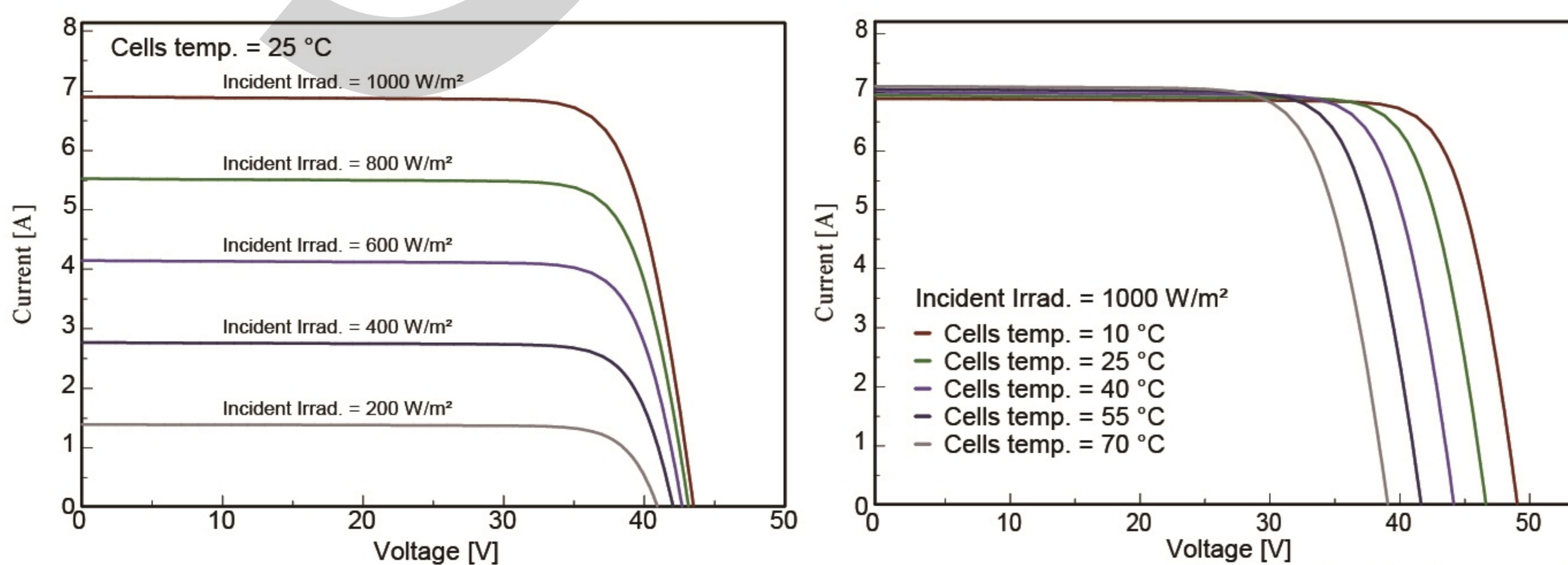

All Dimensions in mm(inch)
The above drawing is a graphical representation of the product.
For engineering quality drawings please contact SUNKET.

Specifications are subject to change without further notification SKT-EN-2017V1.0 © Copyright 2017 Sunket