

For a Free Quote:

Web: **EnergyPal.com/solar**

Call: **1-800-990-3725**

Email: **contact@energypal.com**

EnergyPal

Solar Panel Guide Specification Data Sheet

**Solar Leading Group Limited
SL6M36-150W-170W
SL6M36-165W**

Also available on the web at
EnergyPal.com/solar-leading-group-limited-solar-panels/sl6m36-165w

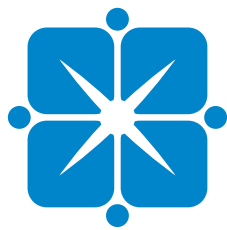

SOLAR LEADING

To a better future

SL6M36-150W-170W

Monocrystalline Photovoltaic Module

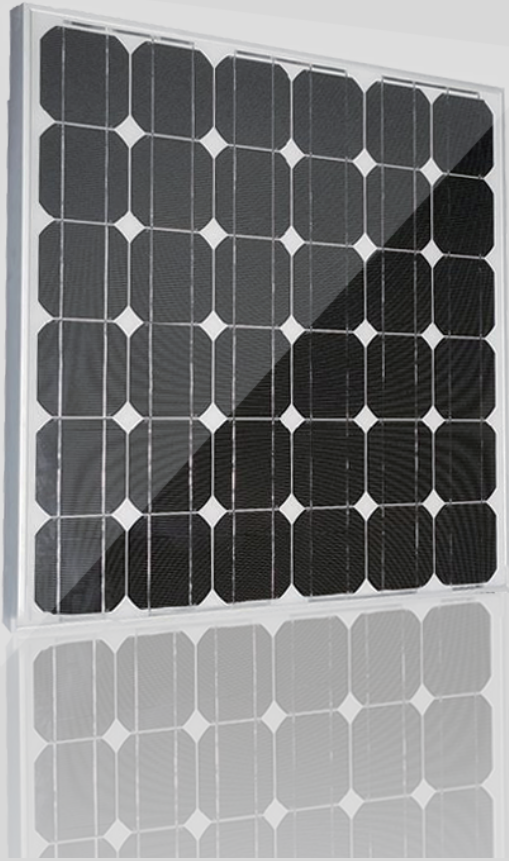

14.23-17.27%
MAXIMUM EFFICIENCY

150-170W
POWER OUTPUT RANGE

36 CELL
MONOCRYSTALLINE MODULE

0~+5W
POSITIVE OUTPUT GUARANTEE



Excellent low light performance on cloudy days, mornings and evenings

- Anti-reflective coating



Great aesthetics for residential applications

- High efficiency, lower weight, Easy handling and optimum utilization of roof space



Certified to withstand challenging environmental conditions

- 2400 Pa wind load
- 5400 Pa snow load
- 35mm hail stone at 97 km/hr



IP68 connectors enhance the reliability of the PV system



Blowing sand resistance certification



Anti-PID



Fire test certification



Ammonia corrosion certification



Salt mist corrosion certification

LINEAR PERFORMANCE WARRANTY

12 Year Product Warranty 25 Year Linear Power Warranty

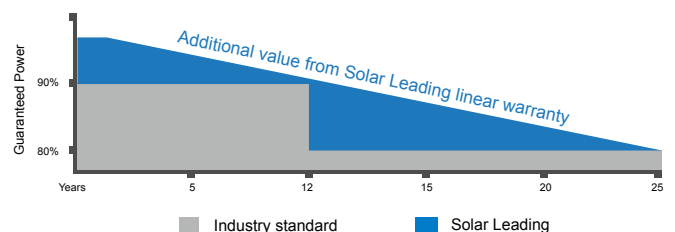

Electrical Characteristics

Characteristics	Unit	SL6M36-150W	SL6M36-155W	SL6M36-160W	SL6M36-165W	SL6M36-170W
Maximum Power (Pmax)	W	150	155	160	165	170
Power Tolerance	W	(0, +5)	(0, +5)	(0, +5)	(0, +5)	(0, +5)
Maximum Power Voltage (Vmp)	V	18.0	18.0	18.0	18.0	18.0
Maximum Power Current (Imp)	A	7.78	8.00	8.88	9.16	9.44
Open Circuit Voltage (Voc)	V	21.6	21.7	21.8	21.9	22.0
Short Circuit Current (Isc)	A	8.00	8.34	8.62	8.96	9.21
Module Efficiency (ηm)	%	14.23	14.74	16.26	16.76	17.27
Dimension of module	mm	992×992×35 mm (39.1 × 39.1 × 1.4 inch)				
Pmax Temperature Coefficient	%/C	-0.48				
Voc Temperature Coefficient	%/C	-0.35				
Isc Temperature Coefficient	%/C	+0.04				
Maximum System Voltage	VDC	600V(UL)/1000V(TUV,IEC)				
Maximum Series Fuse Rating	A	10				
Operating Temperature	°C	-40 ~ +85				
NOCT	°C	45±2				

STC:1000W/m².AM1.5 and 25 °C cell temperature: NOCT : Nominal Operating Cell Temperature

I-V Curves

I-V Curves of PV Module SL6M36-150W
(Cell Temp. 25 °C)

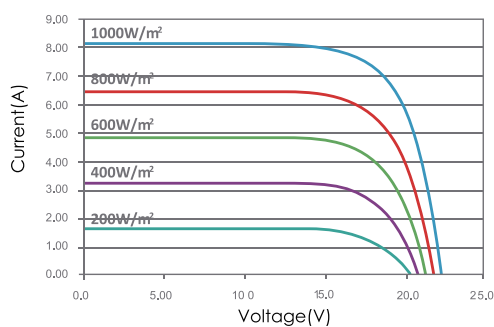

I-V Curves of PV Module SL6M36-150W
at Different Cell Temp. (AM1.5, 1000W/m²)

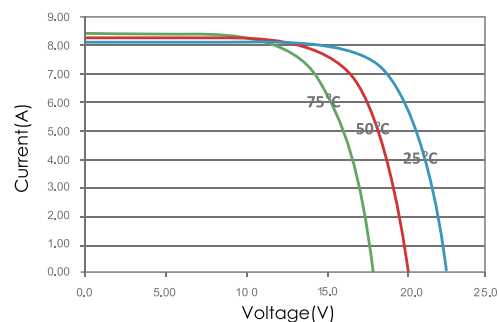

Physical Characteristics

Unit:mm(inch)

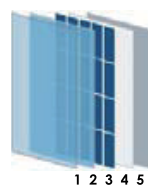
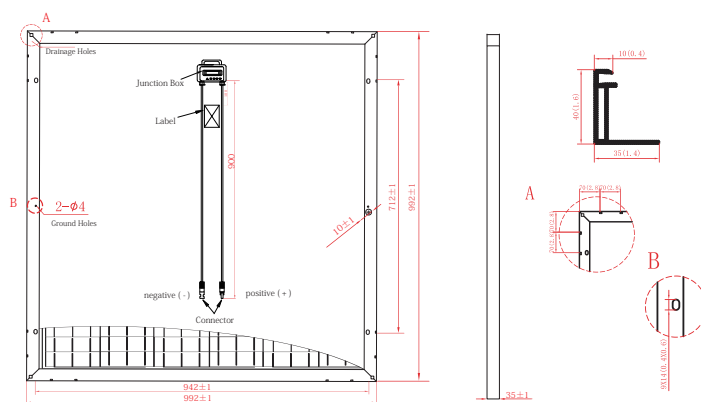

- 1. Tempered Glass
- 2. EVA(Ethylene Vinyl Acetate)
- 3. Solar Cells
- 4. EVA(Ethylene Vinyl Acetate)
- 5. Backsheet

Dimension	992×992×35 mm (39.1 × 39.1 × 1.4 inch)
Weight	11.5 kg (25.4 lbs.)
Cable Length	900 mm (35.4 inch)
Bypass Diodes	2 pcs
Junction Box	IP 65
Front Glass	3.2 mm (0.1inch) tempered low-iron glass
Frame	Anodized aluminum alloy

* Specifications are subjected to change without further notice

