

For a Free Quote:

Web: EnergyPal.com/solar

Call: 1-800-990-3725

Email: contact@energypal.com

EnergyPal

**Solar Panel Guide
Specification Data Sheet**

Sonnett GmbH & Co. KG

SM-72M-165-200

SM-72M-200

Also available on the web at
EnergyPal.com/sonnett-gmbh-co-kg-solar-panels/sm-72m-200

100% solar power and more

SONNETT

Developer of solar- and rainwatertechnologies

PV-SOLARMODULES SONNETT SM



MONOCRYSTALLINE SOLAR MODULES SONNETT SM-72M-xxx

Technical Details

Specification	Pmax Wp(w)	Vmp(V)	Imp(A)	Voc(V)	Isc(A)	Loading p.c./40"
SM-72M-200	200	36.8	5.44	44.9	5.87	644
SM-72M-195	195	36.7	5.32	44.7	5.75	644
SM-72M-190	190	36.6	5.20	44.6	5.62	644
SM-72M-185	185	36.5	5.07	44.5	5.48	644
SM-72M-180	180	36.4	4.95	44.4	5.35	644
SM-72M-175	175	35.9	4.87	44.2	5.29	644
SM-72M-170	170	35.8	4.75	44.1	5.16	644
SM-72M-165	165	35.7	4.62	43.9	5.02	644

STC (Standard-Test Conditions): Irradiance 1000 W/m², Module temperature 25°C, AM=1,5

Operating temperature: -40°C - +85°C
 Max. system voltage: 1000 V DC
 Power tolerance: + 5 W / - 0 W
 Solar cell: Mono crystalline 125 x 125 mm
 Number of cells: 72 (6 x 12)
 Weight: 15,5 kG (8,7 kG bei 36 Zellen)
 Dimension of module: 1580 x 808 x 45 mm (72 Zellen)
 Limited Produkt warrenty: 5 years (10 years with inverter and mounting system)
 Ltd. minimum Pmax warrenty: 10 years at 90 % of the minimum Pmax
 25 years at 80 % of the minimum Pmax

Temperature Coefficients

Nominal Operating Cell Temperature (NOCT): 44°C +/- 2°C
 Peak power temperature coefficient: -0,548 % / °C
 Open-circuit voltage temp. coefficient Voc: -0,396 % / °C
 Short-circuit current temp. coefficient Isc: 0,06 % / °C

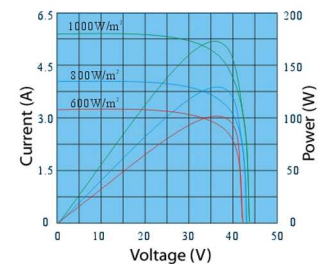
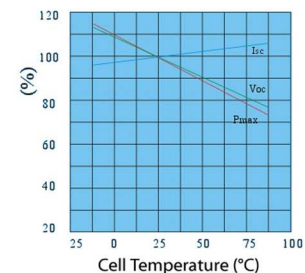
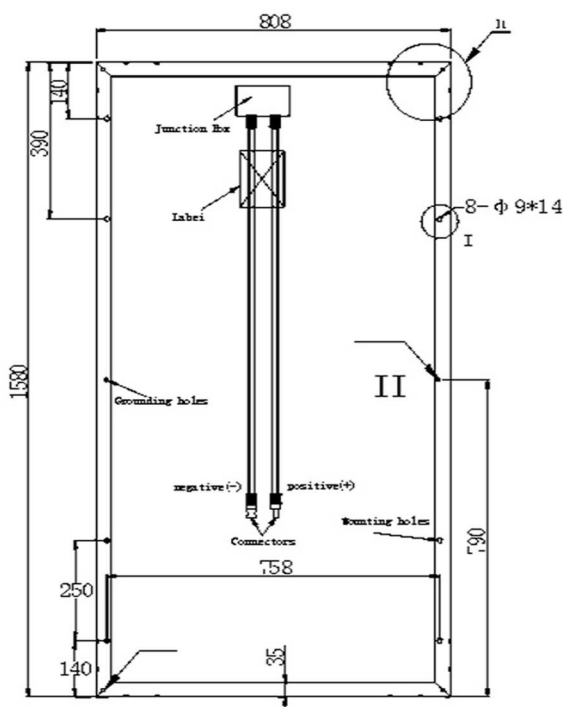

POLYCRYSTALLINE SOLAR MODULES SONNETT SM-72 (60, 54, 48) P-xxx

Technical Details

Specification	Pmax Wp(w)	Vmp(V)	Imp(A)	Voc(V)	Isc(A)	Loading pc./40"
SM-72P-280	280	36.27	7.72	44.50	8.39	396
SM-72P-275	275	36.15	7.61	44.35	8.27	396
SM-72P-270	270	36.03	7.49	44.21	8.15	396
SM-72P-265	265	35.85	7.39	43.99	8.03	396
SM-72P-260	260	35.68	7.29	43.78	7.92	396
SM-60P-235	235	30.22	7.78	37.08	8.45	504
SM-60P-230	230	30.12	7.64	36.96	8.30	504
SM-60P-225	225	30.02	7.49	36.84	8.15	504
SM-60P-220	220	29.83	7.38	36.60	8.02	504
SM-54P-210	210	27.20	7.72	33.37	8.39	600
SM-54P-205	205	27.11	7.56	33.26	8.22	600
SM-54P-200	200	26.89	7.44	32.99	8.09	600
SM-54P-195	195	26.76	7.29	32.83	7.92	600
SM-54P-190	190	26.59	7.15	32.62	7.77	600
SM-54P-185	185	26.50	6.98	32.51	7.59	600
SM-54P-180	180	26.50	6.79	32.51	7.38	600
SM-48P-185	185	24.10	7.68	29.57	8.34	640
SM-48P-180	180	24.02	7.49	29.47	8.15	640
SM-48P-175	175	23.86	7.33	29.28	7.97	640

STC (Standard-Test-Conditions): Irradiance 1000 W/m², Module temperature 25°C, AM=1,5

Operating temperature:	-40°C - +85°C
Max. system voltage :	1000 V DC
Power tolerance:	+/- 3 %
Solar cell:	Poly crystalline 156 x 156 mm
Number of Cells:	72 (6 x 12), 60 (6 x 10), 54 /6 x 9), 48 (6 x 8)
Weight:	SM-72P: 23 kG, SM-60P: 21 kG SM-54P: 18,3 kG, SM-48P: 16,5 kG
Dimension of module:	SM-72P: 1956 x 992 x 50 mm SM-60P: 1640 x 992 x 45 mm SM-54P: 1482 x 992 x 45 mm SM-48P: 1324 x 992 x 45 mm

Temperature coefficients

Nominal Operating Cell Temperature (NOCT):	48°C +/- 2°C
Short-circuit current temperature coefficient:	0,035 %/°C
Open-circuit voltage temperature coefficient	-0,47 %/°C
Peak Power temperature coefficient:	-0,35 %/°C

SONNETT SM-60P-xxx

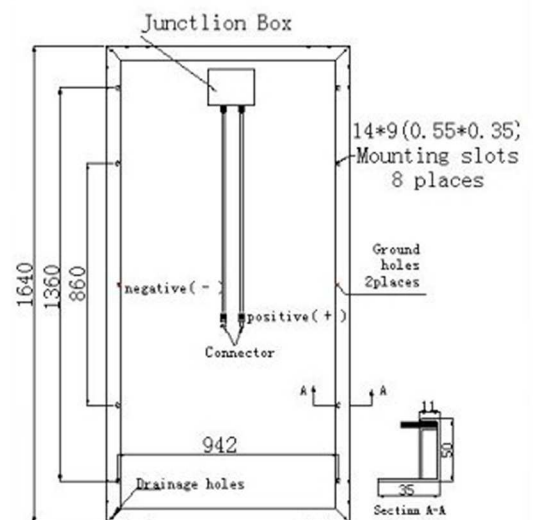

High efficiency with innovative advanced technology

