

**For a Free Quote:**

**Web: [EnergyPal.com/solar](http://EnergyPal.com/solar)**

**Call: 1-800-990-3725**

**Email: [contact@energypal.com](mailto:contact@energypal.com)**

# **EnergyPal**

## **Solar Panel Guide Specification Data Sheet**

**Solartech Power, Inc.**

**SPM040-150P-WP-F**

**SPM090P-WP-F**

Also available on the web at  
[EnergyPal.com/solartech-power-inc-solar-panels/spm090p-wp-f](http://EnergyPal.com/solartech-power-inc-solar-panels/spm090p-wp-f)



**SOLARTECH**<sup>®</sup>  
POWER, INC.

## W-Series 40W PV Module SPM040P-WP-F

### Solartech W-Series Modules

Solartech photovoltaic W-Series Modules are constructed with high efficient polycrystalline solar cells and produce higher output per module than others in its class. This industrial grade module is an industry standard among various industry professionals.

### Features

Class 1, Division 2, (C1D2) Group A,B,C and D

- Accessible junction box with 4-1/2" knockout for ease of installation.
- (EVA) with TPT cushions the solar cells within the laminate and ensures the operating characteristics of the solar cells under virtually any climatic condition
- Rigid anodized aluminum frame and low iron tempered glass
- Easily accessible grounding points on all four corners for fast installation
- Proven junction box technology

### Reliability

- Proven superior field performance
- Tight power tolerance

### Qualifications and Certifications



### Applications

- Traffic & Safety
- Federal Government
- Oil & Gas
- Security
- Telecommunications
- Water and Wastewater
- Weather & Environmental Monitoring
- RV Camper
- Emergency Power
- Telemetry
- SCADA, RTU, GPS
- Marine
- Area Lighting & Sign

## Electrical Characteristics

Max power(Pm)	40W
Maximum power voltage(Vpm)	33.9V
Maximum power current (Ipm)	1.21A
Short circuit current (Isc)	1.30A
Open circuit voltage (Voc)	41.3V
Module efficiency	11.2%
Tolerance	±5%
Nominal Voltage	24V
Temperature coefficient of Voc	-0.36%/K
Temperature coefficient of Pm	-0.46%/K
Temperature coefficient of Isc	0.05%/K
NOCT	48°C ± 2°C
Maximum series fuse rating	10A
Maximum system voltage	600V

## Mechanical Characteristics

Construction	Tempered glass, silicon cell, EVA, Polyester with Tedlar
Solar Cells	36 cells (156mm x26mm) in a 4x17 matrix connected in series
Front Cover	High transmission 3.2mm(1/8") glass
Encapsulant	EVA(Double layers)
Back Cover	White polyester
Frame	Anodized aluminum
Junction Box	IP65, UL94-5VA material
Diodes	Schottky by-pass diodes
Terminal	Accept 8-14 AWG wire
Dimensions	26.2in(666mm)x21.1in(537mm)x1.38in(35mm)
Weight	11.0lb (5.0kg)
Operating Temperature	-40°C~90°C
Storage Humidity	<90%

## IV Curves

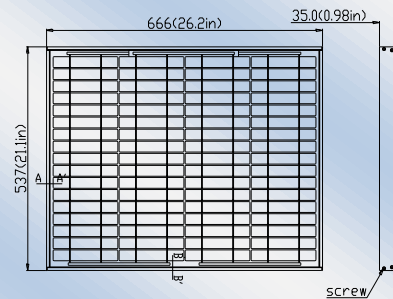
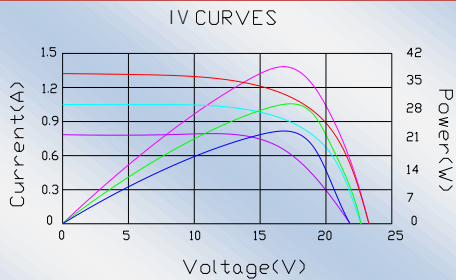

front view

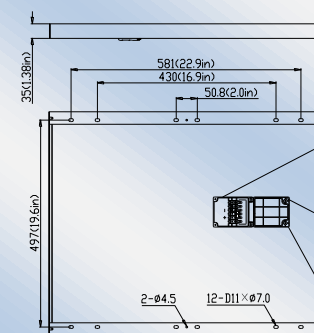

side view

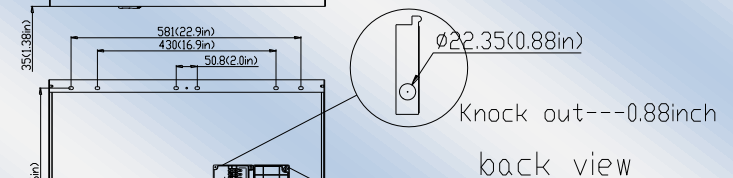

back view

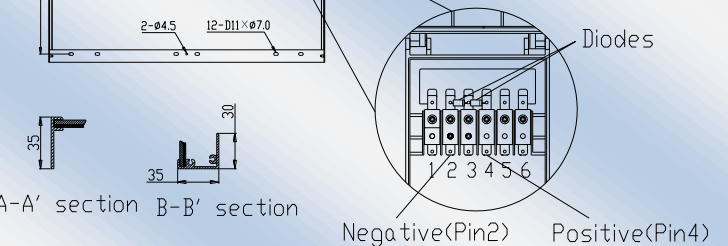

A-A' section B-B' section

Negative(Pin2) Positive(Pin4)

## Warranty

25-year limited warranty of 80% power output;  
12 year limited warranty of 90% power output;  
2-year limited warranty of materials and workmanship\*

## Certifications

UL 1703 certification  
ETL Class I, Division 2, Groups A, B, C and D certification



**SOLARTECH**<sup>®</sup>  
*POWER, INC.*

## W-Series 45W PV Module SPM045P-WP-F

### Solartech W-Series Modules

Solartech photovoltaic W-Series Modules are constructed with high efficient polycrystalline solar cells and produce higher output per module than others in its class. This industrial grade module is an industry standard among various industry professionals.

### Features

Class 1, Division 2, (C1D2) Group A,B,C and D

- Accessible junction box with 4-1/2" knockout for ease of installation.
- (EVA) with TPT cushions the solar cells within the laminate and ensures the operating characteristics of the solar cells under virtually any climatic condition
- Rigid anodized aluminum frame and low iron tempered glass
- Easily accessible grounding points on all four corners for fast installation
- Proven junction box technology

### Reliability

- Proven superior field performance
- Tight power tolerance

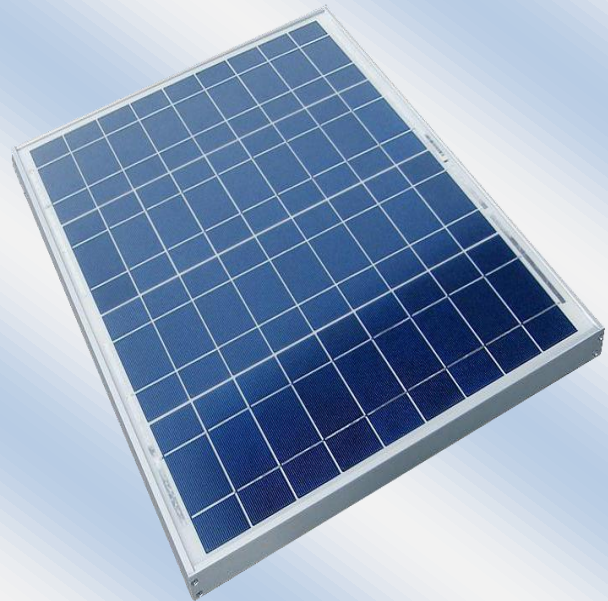

### Applications

- Traffic & Safety
- Federal Government
- Oil & Gas
- Security
- Telecommunications
- Water and Wastewater
- Weather & Environmental Monitoring
- RV Camper
- Emergency Power
- Telemetry
- SCADA, RTU, GPS
- Marine
- Area Lighting & Sign

## Electrical Characteristics

Max power(Pm)	45W
Maximum power voltage(Vpm)	34.2V
Maximum power current (Ipm)	1.32A
Short circuit current (Isc)	1.51A
Open circuit voltage (Voc)	43.1V
Module efficiency	12.1%
Tolerance	±5%
Nominal Voltage	24V
Temperature coefficient of Voc	-0.36%/K
Temperature coefficient of Pm	-0.46%/K
Temperature coefficient of Isc	0.05%/K
NOCT	48°C ± 2°C
Maximum series fuse rating	10A
Maximum system voltage	600V

## Mechanical Characteristics

Construction	Tempered glass, silicon cell, EVA, Polyester with Tedlar
Solar Cells	36 cells (156mm x26mm) in a 4x17 matrix connected in series
Front Cover	High transmission 3.2mm(1/8") glass
Encapsulant	EVA(Double layers)
Back Cover	White polyester
Frame	Anodized aluminum
Junction Box	IP65, UL94-5VA material
Diodes	Schottky by-pass diodes
Terminal	Accept 8-14 AWG wire
Dimensions	26.2in(666mm)x21.1in(537mm)x1.38in(35mm)
Weight	11.0lb (5.0kg)
Operating Temperature	-40°C ~90°C
Storage Humidity	<90%

## IV Curves

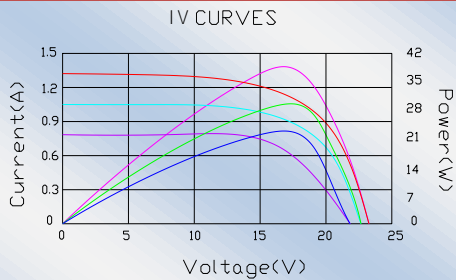

## Warranty

12 year limited warranty of 80% power output  
2-year limited warranty of materials and workmanship\*

## Certifications

UL 1703 certification  
ETL Class I, Division 2, Groups A, B, C and D certification

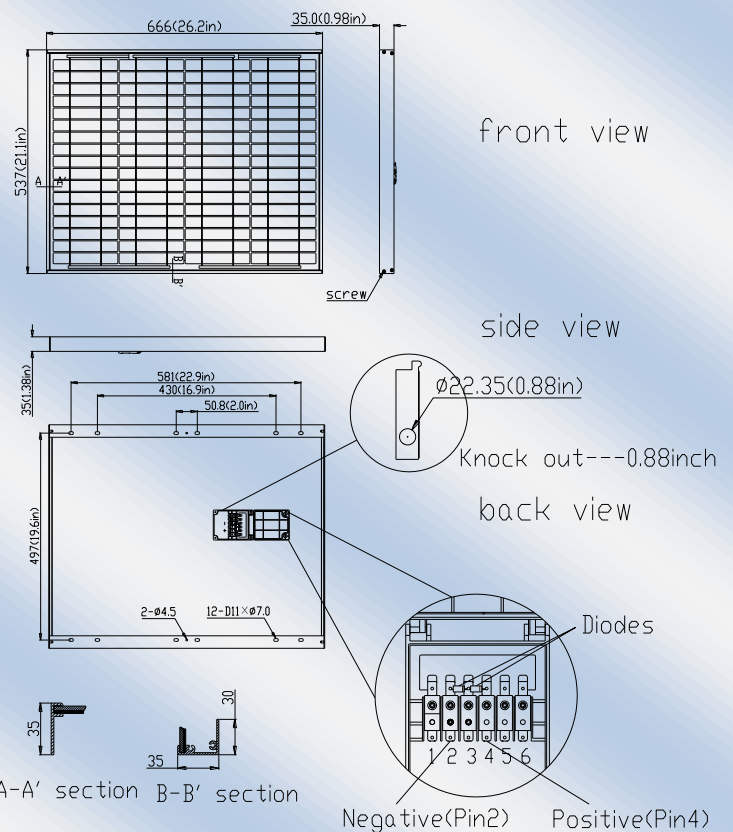





# W-Series 55W PV Module SPM055P-WP-F

## Solartech W-Series Modules

Solartech photovoltaic W-Series Modules are constructed with high efficient polycrystalline solar cells and produce higher output per module than others in its class. This industrial grade module is an industry standard among various industry professionals.

## Features

Class 1, Division 2, (C1D2) Group A,B,C and D

- Accessible junction box with 4-1/2" knockout for ease of installation.
- (EVA) with TPT cushions the solar cells within the laminate and ensures the operating characteristics of the solar cells under virtually any climatic condition
- Rigid anodized aluminum frame and low iron tempered glass
- Easily accessible grounding points on all four corners for fast installation
- Proven junction box technology

## Reliability

- Proven superior field performance
- Tight power tolerance

## Qualifications and Certifications



## Applications

- Traffic & Safety
- Federal Government
- Oil & Gas
- Security
- Telecommunications
- Water and Wastewater
- Weather & Environmental Monitoring
- RV Camper
- Emergency Power
- Telemetry
- SCADA, RTU, GPS
- Marine
- Area Lighting & Sign

## Electrical Characteristics

Max power(Pm)	55W
Maximum power voltage(Vpm)	34.2V
Maximum power current (Ipm)	1.61A
Short circuit current (Isc)	1.85A
Open circuit voltage (Voc)	42.1V
Module efficiency	12.6%
Tolerance	±5%
Nominal Voltage	24V
Temperature coefficient of Voc	-0.36%/K
Temperature coefficient of Pm	-0.46%/K
Temperature coefficient of Isc	0.05%/K
NOCT	48°C ± 2°C
Maximum series fuse rating	10A
Maximum system voltage	600V

## Mechanical Characteristics

Construction	Tempered glass, silicon cell, EVA, Polyester with Tedlar
Solar Cells	36 cells (156mm x32.5mm) in a 4x17 matrix connected in series
Front Cover	High transmission 3.2mm(1/8") glass
Encapsulant	EVA(Double layers)
Back Cover	White polyester
Frame	Anodized aluminum
Junction Box	IP65, UL94-5VA material
Diodes	Schottky by-pass diodes
Terminal	Accept 8-14 AWG wire
Dimensions	25.7in(652mm)x25.2in(639mm)x1.38in(35mm)
Weight	13.2lb (6.0kg)
Operating Temperature	-40°C ~90°C
Storage Humidity	<90%

## IV Curves

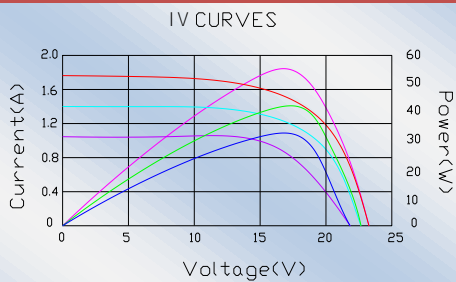

## Warranty

25-year limited warranty of 80% power output;  
12-year limited warranty of 90% power output;  
5-year limited warranty of materials and workmanship

## Certifications

UL 1703 certification  
ETL Class I, Division 2, Groups A, B, C and D certification

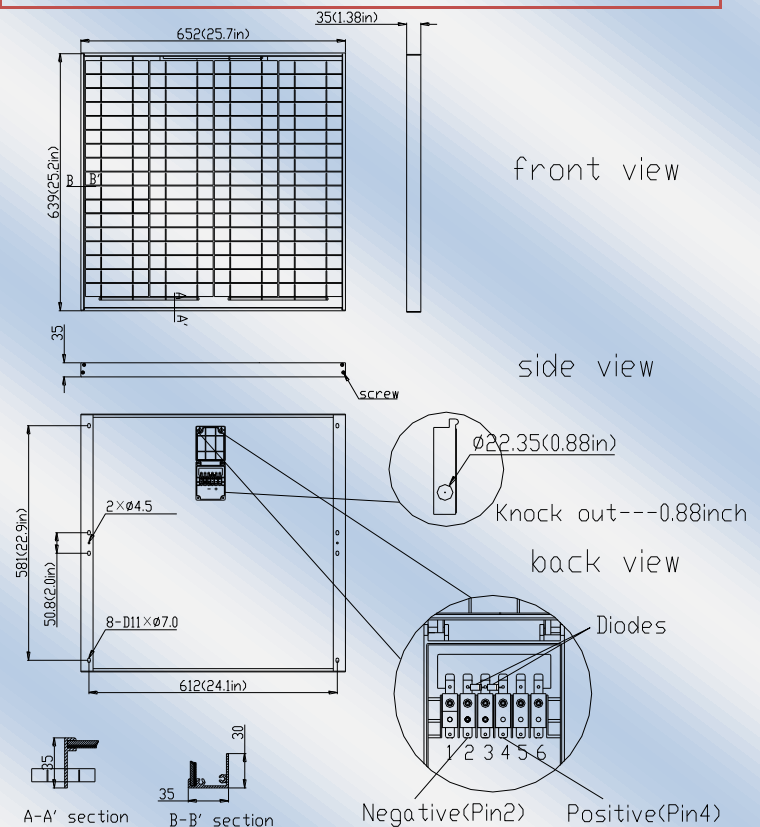



**SOLARTECH**<sup>®</sup>  
POWER, INC.

## W-Series 65W PV Module SPM065P-WP-F

### Solartech W-Series Modules

Solartech photovoltaic W-Series Modules are constructed with high efficient polycrystalline solar cells and produce higher output per module than others in it class. This industrial grade module is an industry standard among various industry professionals.

### Features

Class 1, Division 2, (C1D2) Group A,B,C and D

- Accessible junction box with 4-1/2" knockout for ease of installation.
- (EVA) with TPT cushions the solar cells within the laminate and ensures the operating characteristics of the solar cells under virtually any climatic condition
- Rigid anodized aluminum frame and low iron tempered glass
- Easily accessible grounding points on all four corners for fast installation
- Proven junction box technology

### Reliability

- Proven superior field performance
- Tight power tolerance

### Qualifications and Certifications



### Applications

- Traffic & Safety
- Federal Government
- Oil & Gas
- Security
- Telecommunications
- Water and Wastewater
- Weather & Environmental Monitoring
- RV Camper
- Emergency Power
- Telemetry
- SCADA, RTU, GPS
- Marine
- Area Lighting & Sign



## Electrical Characteristics

Max power(Pm)	65W
Maximum power voltage(Vpm)	36.0V
Maximum power current (Ipm)	1.81A
Short circuit current (Isc)	1.95A
Open circuit voltage (Voc)	43.0V
Module efficiency	12.2%
Tolerance	±5%
Nominal Voltage	24V
Temperature coefficient of Voc	-0.36%/K
Temperature coefficient of Pm	-0.46%/K
Temperature coefficient of Isc	0.05%/K
NOCT	48°C ± 2°C
Maximum series fuse rating	10A
Maximum system voltage	600V

## Mechanical Characteristics

Construction	Tempered glass, silicon cell, EVA, Polyester with Tedlar
Solar Cells	36 cells (156mm x 39mm) in a 4x17 matrix connected in series
Front Cover	High transmission 3.2mm(1/8") glass
Encapsulant	EVA(Double layers)
Back Cover	White polyester
Frame	Anodized aluminum
Junction Box	IP65, UL94-5VA material
Diodes	Schottky by-pass diodes
Terminal	Accept 8-14 AWG wire
Dimensions	38.9in(987mm)x21.3in(540mm)x1.38in(35mm)
Weight	15.4lb (7.0kg)
Operating Temperature	-40°C~90°C
Storage Humidity	<90%

## IV Curves

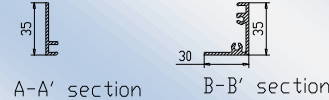
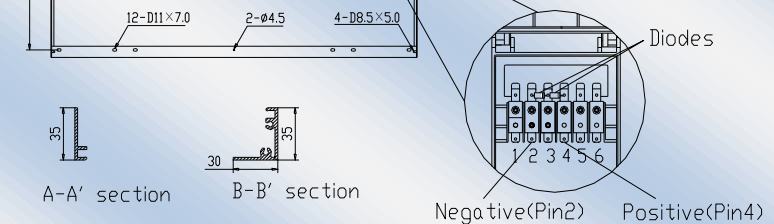
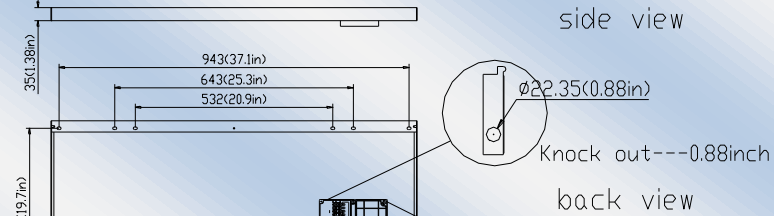
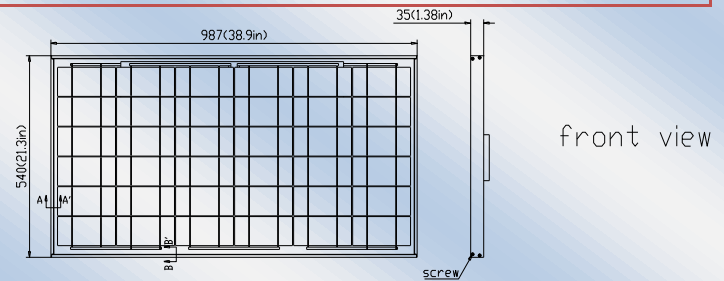
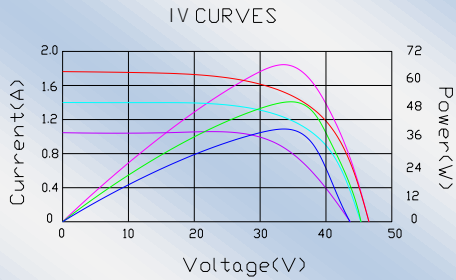

## Warranty

25-year limited warranty of 80% power output;  
12-year limited warranty of 90% power output;  
5-year limited warranty of materials and workmanship

## Certifications

UL 1703 certification  
ETL Class I, Division 2, Groups A, B, C and D certification



**SOLARTECH**<sup>®</sup>  
POWER, INC.

## W-Series 85W PV Module SPM085P-WP-F

### Solartech W-Series Modules

Solartech photovoltaic W-Series Modules are constructed with high efficient polycrystalline solar cells and produce higher output per module than others in its class. This industrial grade module is an industry standard among various industry professionals.

### Features

Class 1, Division 2, (C1D2) Group A,B,C and D

- Accessible junction box with 4-1/2" knockout for ease of installation.
- (EVA) with TPT cushions the solar cells within the laminate and ensures the operating characteristics of the solar cells under virtually any climatic condition
- Rigid anodized aluminum frame and low iron tempered glass
- Easily accessible grounding points on all four corners for fast installation
- Proven junction box technology

### Reliability

- Proven superior field performance
- Tight power tolerance

### Qualifications and Certifications



### Applications

- Traffic & Safety
- Federal Government
- Oil & Gas
- Security
- Telecommunications
- Water and Wastewater
- Weather & Environmental Monitoring
- RV Camper
- Emergency Power
- Telemetry
- SCADA, RTU, GPS
- Marine
- Area Lighting & Sign

## Electrical Characteristics

Max power(Pm)	85W
Maximum power voltage(Vpm)	34.5V
Maximum power current (Ipm)	2.48A
Short circuit current (Isc)	2.62A
Open circuit voltage (Voc)	42.1V
Module efficiency	12.6%
Tolerance	±5%
Nominal Voltage	24V
Temperature coefficient of Voc	-0.36%/K
Temperature coefficient of Pm	-0.46%/K
Temperature coefficient of Isc	0.05%/K
NOCT	48°C ± 2°C
Maximum series fuse rating	10A
Maximum system voltage	600V

## Mechanical Characteristics

Construction	Tempered glass, silicon cell, EVA, Polyester with Tedlar
Solar Cells	36 cells (156mm x 52mm) in a 4x17 matrix connected in series
Front Cover	High transmission 3.2mm(1/8") glass
Encapsulant	EVA(Double layers)
Back Cover	White polyester
Frame	Anodized aluminum
Junction Box	IP65, UL94-5VA material
Diodes	Schottky by-pass diodes
Terminal	Accept 8-14 AWG wire
Dimensions	39.9in(1014mm)x26.3in(669mm)x1.38in(35mm)
Weight	19.8lb (9.0kg)
Operating Temperature	-40°C~90°C
Storage Humidity	<90%

## IV Curves

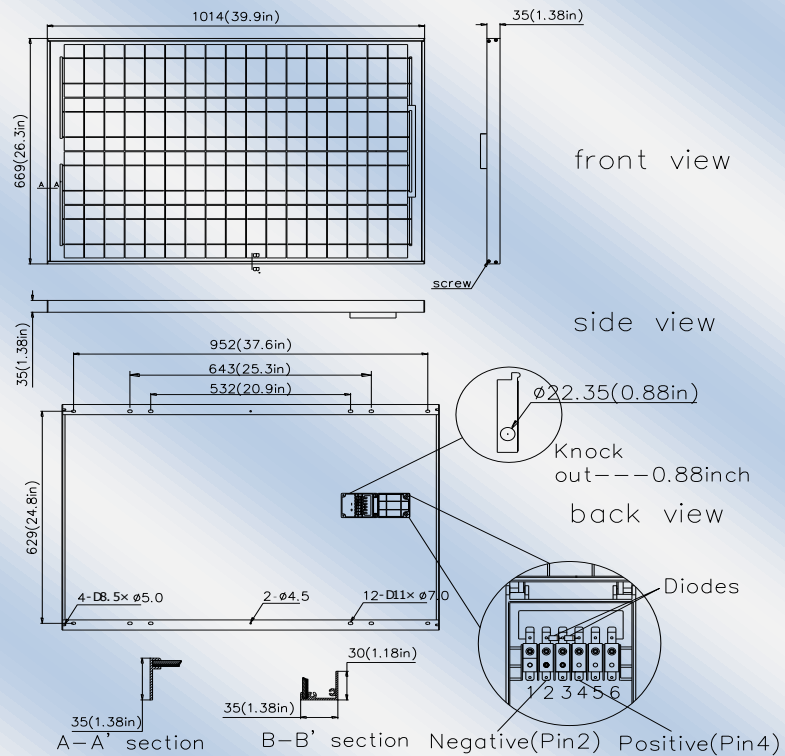
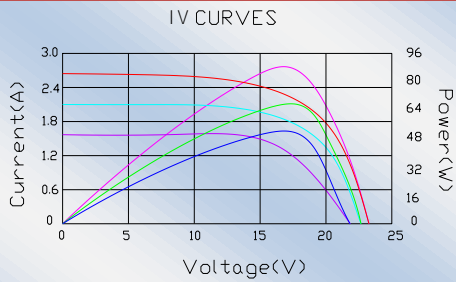

## Warranty

25-year limited warranty of 80% power output;  
12-year limited warranty of 90% power output;  
5-year limited warranty of materials and workmanship

## Certifications

UL 1703 certification  
ETL Class I, Division 2, Groups A, B, C and D certification



**SOLARTECH**<sup>®</sup>  
POWER, INC.

## W-Series 90W PV Module SPM090P-WP-F

### Solartech W-Series Modules

Solartech photovoltaic W-Series Modules are constructed with high efficient polycrystalline solar cells and produce higher output per module than others in its class. This industrial grade module is an industry standard among various industry professionals.

### Features

Class 1, Division 2, (C1D2) Group A,B,C and D

- Accessible junction box with 4-1/2" knockout for ease of installation.
- (EVA) with TPT cushions the solar cells within the laminate and ensures the operating characteristics of the solar cells under virtually any climatic condition
- Rigid anodized aluminum frame and low iron tempered glass
- Easily accessible grounding points on all four corners for fast installation
- Proven junction box technology

### Reliability

- Proven superior field performance
- Tight power tolerance

### Qualifications and Certifications



### Applications

- Traffic & Safety
- Federal Government
- Oil & Gas
- Security
- Telecommunications
- Water and Wastewater
- Weather & Environmental Monitoring
- RV Camper
- Emergency Power
- Telemetry
- SCADA, RTU, GPS
- Marine
- Area Lighting & Sign



## Electrical Characteristics

Max power(Pm)	90W
Maximum power voltage(Vpm)	35.0V
Maximum power current (Ipm)	2.59A
Short circuit current (Isc)	2.72A
Open circuit voltage (Voc)	42.6V
Module efficiency	13.4%
Tolerance	±5%
Nominal Voltage	24V
Temperature coefficient of Voc	-0.36%/K
Temperature coefficient of Pm	-0.46%/K
Temperature coefficient of Isc	0.05%/K
NOCT	48°C ± 2°C
Maximum series fuse rating	12A
Maximum system voltage	600V

## Mechanical Characteristics

Construction	Tempered glass, silicon cell, EVA, Polyester with Tedlar
Solar Cells	36 cells (156mm x 52mm) in a 4x17 matrix connected in series
Front Cover	High transmission 3.2mm(1/8") glass
Encapsulant	EVA(Double layers)
Back Cover	White polyester
Frame	Anodized aluminum
Junction Box	IP65, UL94-5VA material
Diodes	Schottky by-pass diodes
Terminal	Accept 8-14 AWG wire
Dimensions	39.9in(1014mm)x26.3in(669mm)x1.38in(35mm)
Weight	19.8lb (9.0kg)
Operating Temperature	-40°C~90°C
Storage Humidity	<90%

## IV Curves

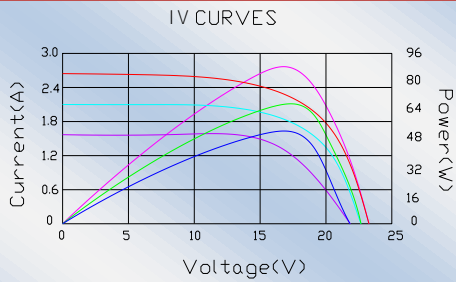

## Warranty

25-year limited warranty of 80% power output;  
12-year limited warranty of 90% power output;  
5-year limited warranty of materials and workmanship

## Certifications

UL 1703 certification  
ETL Class I, Division 2, Groups A, B, C and D certification

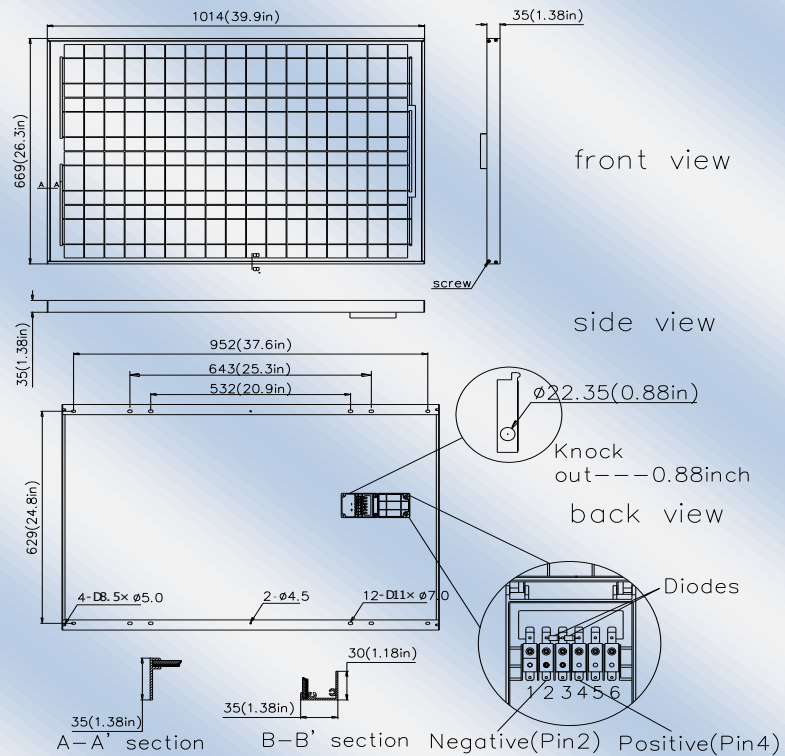



# SPECIFICATIONS

ELECTRICAL CHARACTERISTICS			
Model	SPM150P-WP-F		
Power at STC (Pm)	150W		
Maximum power voltage (Vpm)	34.8V		
Maximum power current (Ipm)	4.3A		
Open circuit voltage (Voc)	42.8V		
Short circuit current (Isc)	4.5A		
Tolerance	±5%		
Module efficiency	15.5%		
Standard test conditions	Temperature 25°C, Irradiance 1000W/m <sup>2</sup> , AM=1.5		
Maximum system voltage	600V DC	Series fuse rating	10A
Temperature coefficient	Isc: 0.05%/K	Voc: -0.36%/K	Pmax: -0.46%/K

Specifications	
Cell	Polycrystalline silicon solar cell, (156mmx78mm)
No. of cell and connection	68 (4x17)
Dimension	1466mm (57.7in) x 660mm (26.0in) x 50mm (1.97in)
Weight	13KG

AMBIENT CONDITIONS	
Operating Temperature	-40°C to +85°C
Storage Humidity	<90%

Output	
Type of output terminal	Junction box
Cable	

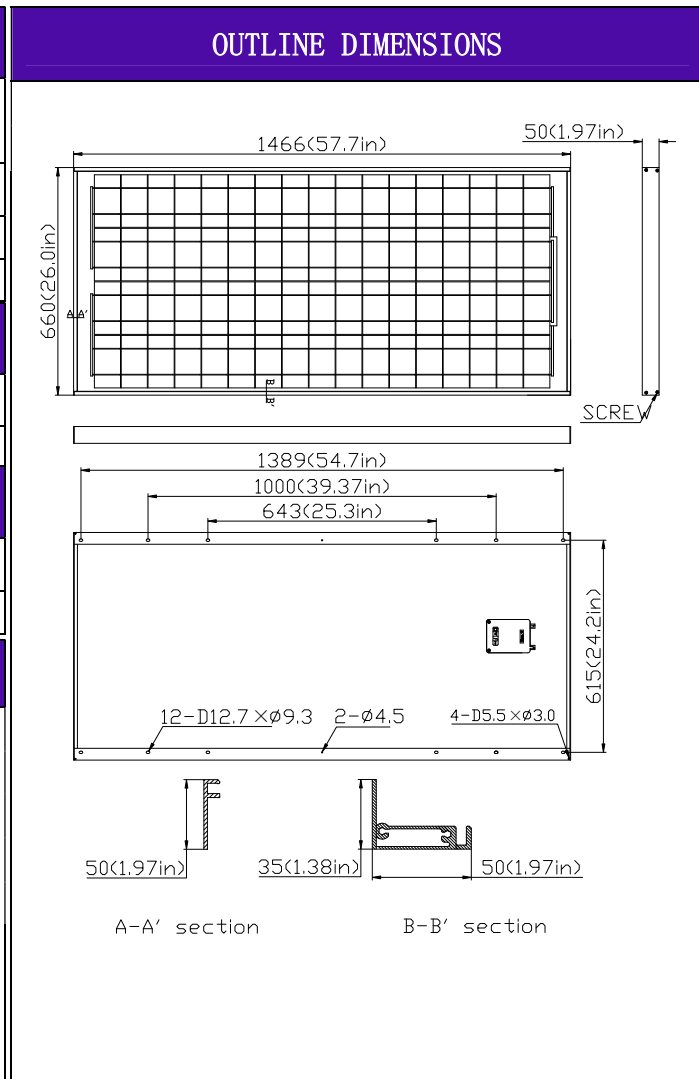
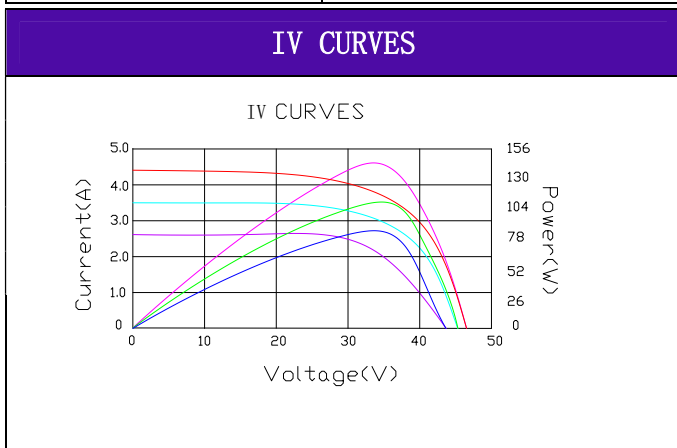

UL STD NO 1703  
ULC/ORD STD NO C1703  
Class 1, Division 2 A, B, C and D,

**SOLARTECH POWER, INC.**  
901 E CEDAR ST  
ONTARIO, CA 91761 USA  
[www.solartechpower.com](http://www.solartechpower.com)  
[sales@solartechpower.com](mailto:sales@solartechpower.com)  
TOLL: 866-777-6527  
TEL: 909-673-0178  
FAX: 909-947-2919