

For a Free Quote:

Web: EnergyPal.com/solar

Call: 1-800-990-3725

Email: contact@energypal.com

EnergyPal

Solar Panel Guide Specification Data Sheet

**SunPower Corp.
SPR-P17-335-355-COM
SPR-P17-350-COM**

Also available on the web at
EnergyPal.com/sunpower-corp-solar-panels/spr-p17-350-com



SunPower® Performance Series 1500 Volt | P17

SunPower® Performance Series 1500 Volt panels are designed to deliver consistent performance for many decades in advanced 1500 Volt power plant applications.

Increased Energy Production

The Performance Series modules' linear shading response enables true-tracking in single-axis tracking systems, generating more energy than conventional systems that require backtracking.¹

Design Tip: When modeling P-Series energy performance be sure to use linear shading losses. For more detailed guidance please visit <https://us.sunpower.com/sites/sunpower/files/media-library/manuals/mn-sunpower-p-series-modeling-guide.pdf>

Higher Efficiency

The Performance Series design minimizes white space between solar cells, eliminates reflective metal lines on the cells, and lowers electrical resistance between cells, increasing efficiency compared to Conventional Commercial Panels.²

Optimized for the Oasis Power Plant

From the mounting hardware, to the electrical design within the panel, to the connectors and the 1500 V rating, everything is designed as an integral part of the Oasis Power Plant.

High Reliability

Innovative panel design uses flexible and redundant electrical connections between solar cells to deliver enhanced reliability.

SunPower Quality

Tested to SunPower's rigorous quality standards, and backed by the industry's best Combined Power and Product Warranty.

High Performance & Excellent Reliability

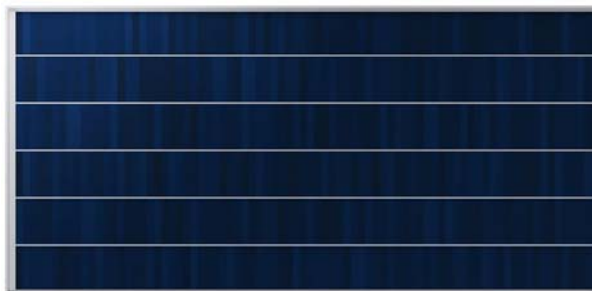

SPR-P17-355-COM



25 Year Combined Warranty

Protect your investment

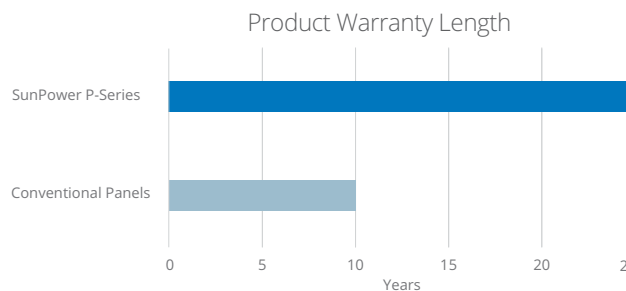

SunPower provides the best 25 year Combined Power and Product warranty in the industry, providing coverage regardless of product defect or power loss.

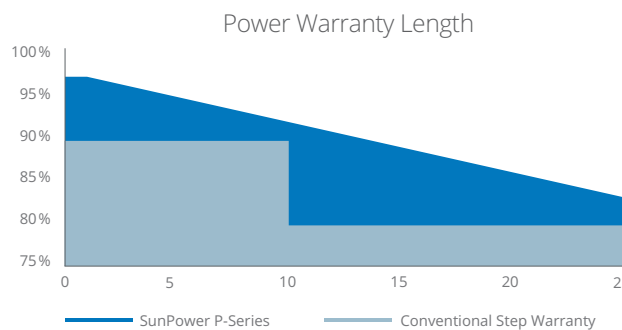

SunPower's Performance Series is warranted to produce more than 97% power in the first year, then declining by 0.6% per year, ending at 82.6% power after 25 years.

SunPower® Performance Series 1500 Volt | P17

Electrical Data, STC ³					
Model	SPR-P17-355-COM	SPR-P17-350-COM	SPR-P17-345-COM	SPR-P17-340-COM	SPR-P17-335-COM
Nominal Power (P _{nom})	355 W	350 W	345 W	340 W	335 W
Power Tolerance	+5/-0%	+5/-0%	+5/-0%	+5/-0%	+5/-0%
Efficiency	17.2%	17.0%	16.7%	16.5%	16.2%
Rated Voltage (V _{mpp})	43.4 V	43.1 V	42.8 V	42.5 V	42.2 V
Rated Current (I _{mpp})	8.18 A	8.12 A	8.06 A	8.00 A	7.94 A
Open-Circuit Voltage (V _{oc})	51.9 V	51.7 V	51.5 V	51.3 V	51.1 V
Short-Circuit Current (I _{sc})	8.68 A	8.65 A	8.57 A	8.52 A	8.51 A
Power Temp. Coef.	-0.37% / °C				
Voltage Temp. Coef.	-176.5 mV / °C	-175.8 mV / °C	-175.1 mV / °C	-174.4 mV / °C	-173.7 mV / °C
Current Temp. Coef.	3.6 mA / °C				
Maximum System Voltage	1500 V UL & 1500 V IEC				
Maximum Series Fuse	15 A				

Operating Condition And Mechanical Data	
Temperature	-40° F to +185° F (-40° C to +85° C)
Impact Resistance	1 inch (25 mm) diameter hail at 52 mph (23 m/s)
Appearance	Class B
Solar Cells	Multicrystalline cells
Tempered Glass	High-transmission tempered anti-reflective
Junction Box	IP-67, landscape and portrait cable options / MC4 compatible
Weight	51 lbs (23.1 kg)
Max. Load	G6 Frame: Wind: 50 psf, 2400 Pa front & back Snow: 50 psf, 2400 Pa front
	G4 Frame: Wind: 50 psf, 2400 Pa front & back Snow: 112 psf, 5400 Pa front
Frame	Class 2 silver anodized; stacking pins

Tests And Certifications	
Standard Tests ⁴	UL1703 (Type 2 Fire Rating), IEC 61215, IEC 61730 Rated to 1500 V
Quality Certs	ISO 9001:2008, ISO 14001:2004
EHS Compliance	OHSAS 18001:2007, PV Cycle
Ammonia Test	IEC 62716
Desert Test	10.1109/PVSC.2013.6744437
Salt Spray Test	IEC 61701 (maximum severity)
PID Test	Potential-Induced Degradation free: 1500 V
Available Listings	UL, CEC, TUV, FSEC

REFERENCES:

- 1 Independent Shade Study by CFV Laboratory.
- 2 Compared to a Conventional Commercial Panel (310 W, 16% efficient, approx. 1.93 m²).
- 3 Measured at Standard Test Conditions (STC): irradiance of 1000 W/m², AM 1.5, and cell temperature 25° C.
- 4 Type 2 fire rating per UL1703:2013, Class C fire rating per UL1703:2002 and IEC 61730.

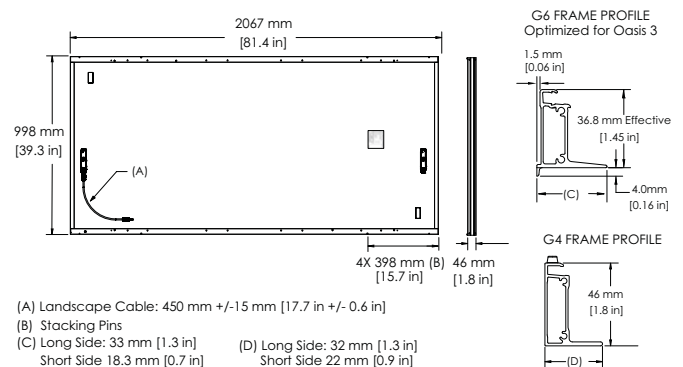

Read safety and installation instructions before using this product.