

For a Free Quote:

Web: **EnergyPal.com/solar**

Call: **1-800-990-3725**

Email: **contact@energypal.com**

EnergyPal

Solar Panel Guide Specification Data Sheet

Shenzhen Suoyang New Energy Co., Ltd.

SY-60-255-275WP

SY-60- 265W

Also available on the web at

EnergyPal.com/shenzhen-suoyang-new-energy-co-ltd-solar-panels/sy-60-265w

PRODUCT SPECIFICATION

Type Of Module	SY-60-255W	SY-60-260W	SY-60-265W	SY-60-270W	SY-60-275W
Maximum Power (W)	255	260	265	270	275
Tolerance (%)	± 3%	± 3%	± 3%	± 3%	± 3%
Open Circuit Voltage (V)	37.6	37.8	37.9	38	38.1
Short Circuit Current (A)	8.66	8.76	8.86	8.96	9.06
Maximum Power Voltage (V)	31	31.2	31.3	31.5	31.6
Maximum Power Current (A)	8.23	8.33	8.47	8.57	8.7
Module Efficiency (%)	15.7	16	16.3	16.6	16.9
Solar Cell Efficiency (%)	17.7	18	18.3	18.6	18.9
Series Fuse Rating (A)	15	15	15	15	15
Terminal Box	IP65	IP65	IP65	IP65	IP65
Maximum system voltage (V)	DC1000	DC1000	DC1000	DC1000	DC1000
Operating Temperature(°C)	-40°C -- 85°C	-40°C -- 85°C	-40°C -- 85°C	-40°C -- 85°C	-40°C -- 85°C



PRODUCT FEATURE

- Bypass diode minimizes the power drop by shade.
- The conversion efficiency of solar cell is above 18.0%.
- White tempered glass ,EVA resin,weather proof film and anodized aluminum frame to provide efficient protection from the severest environmental conditions.
- Waterproof.Perfect for grid applications.
- Product guarantee 10 years.

Quality Assurance

- Electrical Insulation test
- Outdoor exposure test
- Hot-spot endurance test
- UV-exposure
- Thermal cycling test
- Humidity freeze test
- Damp heat Test
- Robustness of terminations test
- Wet leakage current test
- Mechanical load test
- Hail impact test
- Bypass diode thermal test

Electric Performance Typical Performance Characteristics

Short Circuit Current Temperature Coefficient	%/°C	0.06
Open Circuit Voltage Temperature Coefficient	%/°C	-0.34
Maximum Power Temperature Coefficient	%/°C	-0.47
Performance Warranty : 90%output , 12 years		
80%output, 25 years		

Physical Specifications

Dimension: 1640*992*35MM
 Weight: 18KG/PCS
 Packing : 2 pcs in one carton

Electrical Characteristics

Current-Voltage & Power-Voltage characteristics various irradiance levels

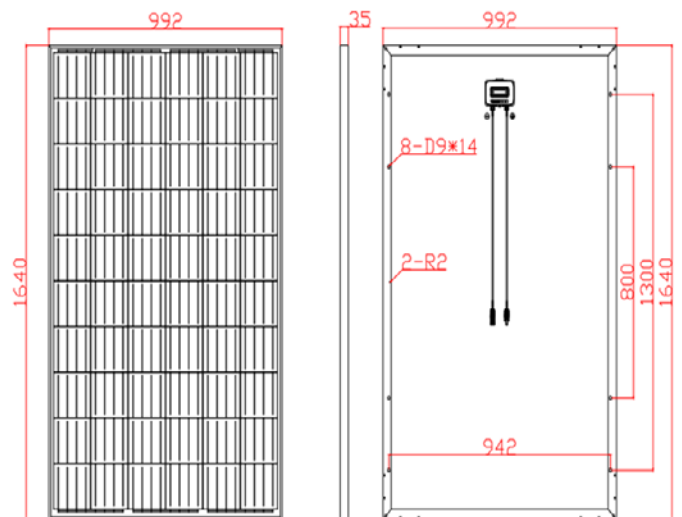
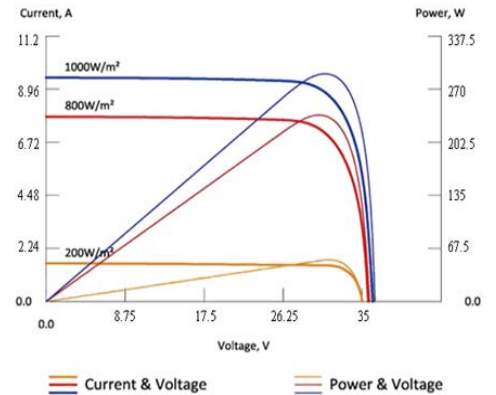

SHENZHEN SUOYANG NEW ENERGY CO.,LTD.

ADD.: No.5 Building,Juhui Mold Industrial area,Tianliao Road,Guangming New Districte ,Shenzhen ,China

Tel: +86- 755 3369 9192 -8004 Fax: +86-755 3369 9194

Website: www.szsuo yang.com