

For a Free Quote:

Web: EnergyPal.com/solar

Call: 1-800-990-3725

Email: contact@energypal.com

EnergyPal

Solar Panel Guide Specification Data Sheet

**Suntellite Group - Hangzhou Sunny Energy Science
and Technology Co., Ltd
ZDNY-320C72-340C72
ZDNY-335C72**

Also available on the web at
EnergyPal.com/suntellite-group-hangzhou-sunny-energy-science-and-technology-co-ltd-solar-panels/zdny-335c72



Premium Series

SUNTELLITE MODULE MONOCRYSTALLINE

ZDNY-320C72	320Wp
ZDNY-325C72	325Wp
ZDNY-330C72	330Wp
ZDNY-335C72	335Wp
ZDNY-340C72	340Wp

ZDNY-***CB72 All black series as optional



Key Features

- High-yield modules with high level of efficiency :**
 Automatic cell and module production with 100% quality control and product trace-ability.
 0 to +3% of positive power tolerance guaranteed
 PID Free(Potential Induced Degradation)
- Heavy Load mechanical resistance :**
 TUV Certified (5400Pa tested against snow and 2400Pa against the wind)
- The production system is ISO9001, ISO14001, OHSAS18001 certified**
- Fire Test Approved :**
 Application class A, Safety Class II, Fire Rating A
- High Salt mist and ammonia resistance**
- Enhanced design for easy installation and long-term reliability.**



Warranty

- 12 years limited workmanship warranty.
- No less than 97% output power in the first year.
- No more than 0.7% annual declination since the second year.
- 25 year warranty at 80.2% power output.
- Product liability and E&O insurance has been covered by Chubb Insurance



Typical electrical characteristics

Characteristics	ZDNY-320C72	ZDNY-325C72	ZDNY-330C72	ZDNY-335C72	ZDNY-340C72
Max.Power(Pmax)	320Wp	325Wp	330Wp	335Wp	340Wp
Optimum Operating Voltage(Vm)	37.15V	37.46V	37.65V	37.88V	38.02V
Optimum Operating Current(Im)	8.62A	8.68A	8.77A	8.85A	8.95A
Open-circuit Voltage(Voc)	45.96V	46.25V	46.45V	46.67V	46.79V
Short-circuit Current(Isc)	9.10A	9.16A	9.23A	9.29A	9.37A
Cell Efficiency	18.60%	18.89%	19.18%	19.47%	19.76%
Module efficiency	16.49%	16.75%	17.01%	17.26%	17.52%

- STC (Standard Test Condition): Irradiance 1000W/m², Module Temperature 25°C, AM=1.5
- NOCT: Irradiance 800W/m², ambient Temperature 20°C, wind speed 1m/s

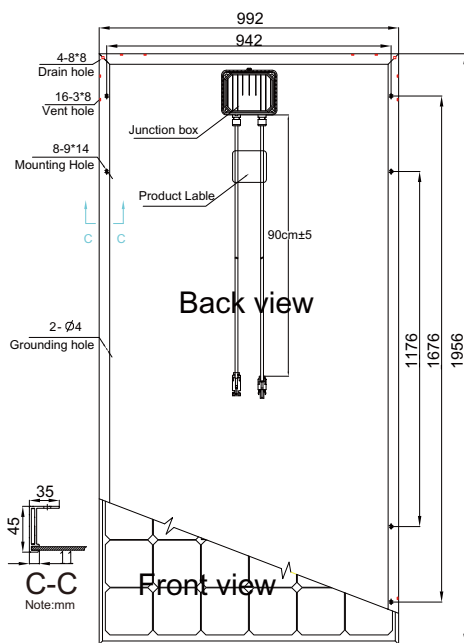

Solar Cell	Mono-crystalline 156*156mm
Output Tolerance(Pmax)	0 ~ +3%
Number of cells	72 cells in series
Module Dimension	1956*992*45mm
Weight	23.00kg
Max.System Voltage	1000V(TUV)/1000V(UL)
Max.Series Fuse Rating	15A
Output Cable	PV 4mm ²
Cable Length	90cm±5
Number of bypass diodes	3
Temperature cycling range	(-40 ~ 85 °C)
NOCT	47°C ±2°C
Temperature coefficients of Isc	+0.053%/K
Temperature coefficients of Voc	-0.303%/K
Temperature coefficients of Pmax	-0.40%/K
Load Capacity	230pcs/20'GP
	600pcs/40'HQ

I-V Curves of PV module ZDNY-320C72 at various cell temperatures

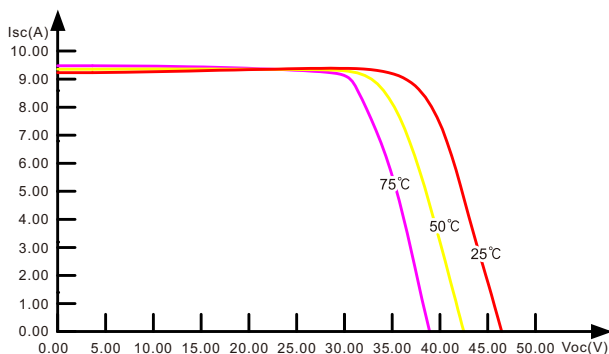

I-V Curves of PV module ZDNY-320C72 at various solar irradiance

